



www.rodneyind.com.au

IRRIGATION VALVES, PIPE AND FITTINGS

For range and reliability,
choose Rodney Industries









CONTACT US

PH: 07 3624 0300

sales@rodneyind.com.au
www.rodneyind.com.au

19 Valente Close,
Chermside QLD 4032

INDEX

	Irrigation Valves and Strainers	PAGE	01
	Goosenecks and Flanged Pipe	PAGE	11
	Galvanized, Stainless Steel and Aluminium Fittings	PAGE	15
	Floats and pontoons	PAGE	31
	Polyethylene Fittings	PAGE	35
	Irrigation Fittings	PAGE	53
	Technical Drawings	PAGE	63

INDEX

Footvalves	PAGE 02
Eco Check Valves	PAGE 04
Gate Check Valves	PAGE 05
Check Valves	PAGE 06
Right Angle Discharge Valve	PAGE 06
Eco Flap Valves	PAGE 07
Gibault Joints	PAGE 07
Strainers	PAGE 08
Valve Spare Parts	PAGE 09
Goosenecks	PAGE 12
Flanged Pipe	PAGE 12
Bends	PAGE 16
Tees	PAGE 18
Tapers	PAGE 19
Flange Support Brackets	PAGE 21
Bore Caps	PAGE 21
Flanges and Gaskets	PAGE 22
Connectors	PAGE 23
Hose Ends	PAGE 25
Hose Joiners, Tails and Clamps	PAGE 26
Aluminium Reducers	PAGE 27
Aluminium Tees	PAGE 27

INDEX

Aluminium Crosses	PAGE 28
Aluminium Bends	PAGE 29
Aluminium Starters and Ends	PAGE 30
Floats and pontoons	PAGE 32
Segmented Bends	PAGE 36
Sweep Bends	PAGE 38
Stub Flanges	PAGE 40
Maxi Stubs	PAGE 41
Valve Spacers	PAGE 42
Shouldered Ends	PAGE 42
Nuts, Bolts and Gasket Kits	PAGE 43
Moulded Bends and Tees	PAGE 44
End Caps	PAGE 46
Reducers	PAGE 47
Backing Rings	PAGE 49
Joiners	PAGE 54
Couplers	PAGE 55
Adaptors	PAGE 56
Weld Bells	PAGE 57
Clamps and Gaskets	PAGE 58
Bauer Style Fittings	PAGE 59
Technical Drawings	PAGE 63



IRRIGATION VALVES & STRAINERS

With a range that expands over 100 types and sizes, you are sure to find the Valve and Strainer to suit your requirements. If you don't ... we can make it!

- Large range of Valves available in sizes to suit your requirements.
- For use in a wide range of applications, including: ocean outlets, transfer ponds, channels.
- Hot dipped galvanized.
- Spare parts readily available.



FOOTVALVES



Please note:
Spring Loaded Code includes factory fitted spring.



Standard Galvanized (Table D)

mm	Inches	Code	Price	Spring Load Code	Spring Load Price
80	3	6515	519.20	6515SL	585.20
100	4	6525	565.40	6525SL	631.40
125	5	6535	651.80	6535SL	717.80
150	6	6545	761.30	6545SL	827.30
200	8	6565	1,045.00		
250	10	6585	1,312.90		
300	12	6595	1,889.40		
350	14	6590	2,606.50		
375	15	6605	3,945.10		
400	16	6615	4,596.30		
450	18	6625	5,129.30		
500	20	6635	5,616.80		
600	24	6645	7,285.80		
660	26	6647	7,569.50		
750	30	6650	12,316.80		

Stainless Steel 316 (Table D)



mm	Inches	Code	Price	Spring Load Code	Spring Load Price
80	3	6515SS316	2,229.90	6515SS316SL	2,295.90
100	4	6525SS316	1,021.80	6525SS316SL	1,087.80
125	5	6535SS316	1,250.10	6535SS316SL	1,316.10
150	6	6545SS316	1,488.30	6545SS316SL	1,554.30
200	8	6565SS316	2,293.70		
250	10	6585SS316	4,319.20		
300	12	6595SS316	5,191.20		
350	14	6590SS316	P.O.A		
375	15	6605SS316	P.O.A		
400	16	6615SS316	P.O.A		
450	18	6625SS316	P.O.A		
500	20	6635SS316	P.O.A		
600	24	6645SS316	P.O.A		

Poly Housing G-10 Glass Resin & 316 Stainless Steel



Size		Code	Price	Spring Loaded Code	Spring Loaded Price
mm	inches				
100	4	FVPS100	2,349.90	FVPS100SI	2,415.90
125	5	FVPS125	2,774.10	FVPS125SI	2,840.10
150	6	FVPS150	2,991.70	FVPS150SL	3,057.70
200	8	FVPS200	4,129.10		
250	10	FVPS250	5,382.80		
300	12	FVPS300	6,160.40		

SQUAT STYLE FOOTVALVES

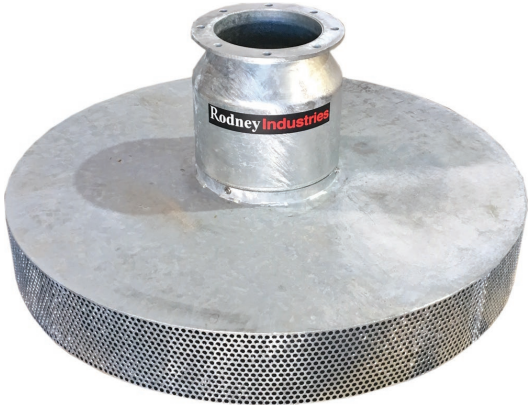

Squat Style Footvalves (Table D)

mm	Inches	DIA (mm)	Screen Height (mm)	Code	Price
100	4	600	155	6525SQ600	1,253.40
100	4	900	155	6525SQ900	1,339.30
125	5	600	170	6535SQ600	1,299.70
125	5	900	170	6535SQ900	1,418.50
150	6	600	170	6545SQ600	1,458.10
150	6	900	170	6545SQ900	1,576.80
200	8	600	170	6565SQ600	1,622.90
200	8	900	170	6565SQ900	1,741.60
200	8	1200	170	6565SQ1200	1,946.20
250	10	900	170	6585SQ900	2,091.30
250	10	1200	170	6585SQ1200	2,460.80
300	12	900	170	6595SQ900	2,289.20
300	12	1200	170	6595SQ1200	2,704.80

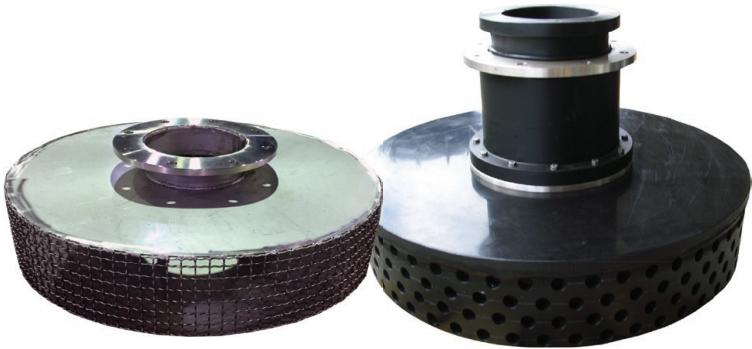

Also available in Stainless Steel and Polyethylene. Contact our sales office for further details.

ECO CHECK VALVES



Standard (Table D)

mm	Inches	Code	Price
80	3	6360	1,228.20
100	4	6370	1,570.10
125	5	6380	1,966.70
150	6	6390	1,970.50
200	8	6410	2,597.90
250	10	6420	4,343.70
300	12	6430	4,478.80
350	14	6440	6,933.90
375	15	6450	7,249.20
400	16	6460	7,452.80
450	18	6470	7,999.00
500	20	6480	9,154.20
600	24	6490	10,971.80
660	26	6500	11,905.60
660/750	26/30	6502	12,359.80
660/900	26/36	6504	13,069.70



With Bypass (Table D)

mm	Inches	Bypass Size	Code	Price
80	3	20 copper	6360BP	1,579.70
100	4	20 copper	6370BP	2,003.40
125	5	20 copper	6380BP	2,400.00
150	6	20 copper	6390BP	2,322.50
200	8	20 copper	6410BP	3,043.90
250	10	32 gal	6420BP	4,747.80
300	12	32 gal	6430BP	4,883.60
350	14	40 gal	6440BP	7,681.70
375	15	40 gal	6450BP	7,999.00
400	16	50 gal	6460BP	8,145.50
450	18	50 gal	6470BP	8,748.30
500	20	60 gal	6480BP	10,099.40
600	24	60 gal	6490BP	12,247.40
660	26	80 gal	6500BP	13,227.00
660/750	26/30	80 gal	6502BP	13,680.00
660/900	26/36	80 gal	6504BP	14,390.40



Valve complete with inspection hatch
Please let sales department know when ordering if you require the hatch. (For sizes 14” and up).

GATE CHECK VALVES



Standard (Table D)

mm	Inches	Code	Price
80	3	6815	1,629.70
100	4	6825	1,766.80
125	5	6835	2,016.20
150	6	6845	2,146.30
200	8	6865	2,714.60
250	10	6885	4,293.60
300	12	6895	5,303.60
350	14	6905	6,895.30
400	16	6925	7,603.30
450	18	6935	10,091.50
500	20	6945	11,395.80
600	24	6955	13,167.70
660	26	6960	16,121.40
750	30	6965	17,941.50
660/750	26/30	6502	12,359.80
660/900	26/36	6504	13,069.70



With Bypass (Table D)

mm	Inches	Bypass Size	Code	Price
80	3	20 copper	6815BP	1,949.50
100	4	20 copper	6825BP	2,111.90
125	5	20 copper	6835BP	2,415.20
150	6	20 copper	6845BP	2,531.40
200	8	20 copper	6865BP	3,093.40
250	10	32 gal	6885BP	4,617.20
300	12	32 gal	6895BP	5,968.50
350	14	40 gal	6905BP	7,747.30
400	16	50 gal	6925BP	7,902.70
450	18	50 gal	6935BP	10,320.50
500	20	65 gal	6945BP	12,726.10
600	24	65 gal	6955BP	14,572.90
660	26	80 gal	6960BP	16,840.20
750	30	80 gal	6965BP	18,520.80
660/750	26/30	80 gal	6502BP	13,680.00
660/900	26/36	80 gal	6504BP	14,390.40

CHECK VALVE



Standard (Table D)

mm	Inches	Code	Price
80	3	6655	1,257.40
100	4	6665	1,365.30
125	5	6675	1,588.00
150	6	6685	1,639.30
200	8	6705	2,373.30
250	10	6725	3,866.70
300	12	6735	4,846.30
350	14	6745	6,397.90
375	15	6755	6,546.50
400	16	6765	7,081.90
450	18	6775	8,299.90
500	20	6785	9,663.30
600	24	6795	11,496.70
660	26	6797	14,159.80
750	30	6805	16,189.40



With Bypass (Table D)

mm	Inches	Bypass Size	Code	Price
80	3	20 copper	6655BP	1,577.20
100	4	20 copper	6665BP	1,708.40
125	5	20 copper	6675BP	1,982.50
150	6	20 copper	6685BP	2,007.80
200	8	20 copper	6705BP	2,755.90
250	10	32 gal	6725BP	4,195.30
300	12	32 gal	6735BP	5,511.10
350	14	40 gal	6745BP	7,249.40
375	15	40 gal	6755BP	7,402.20
400	16	50 gal	6765BP	7,898.40
450	18	50 gal	6775BP	9,111.30
500	20	65 gal	6785BP	10,807.60
600	24	65 gal	6795BP	13,084.50
660	26	80 gal	6797BP	15,848.70
750	30	80 gal	6805BP	16,771.00



Right Angle Discharge Valve (Table D)

Inlet		Outlet		Code	Price
mm	Inches	mm	Inches		
50&65	2&2½	100&125	4&5	R22545	2,032.30
50&65	2&2½	125&150	5&6	R22556	2,389.70
65&80	2½&3	100&125	4&5	R25345	3,639.60
80&100	3&4	125&150	5&6	R3456	3,700.30
125&150	5&6	200	8	R568	3,926.10

ECO FLAP VALVES



Standard Eco Flap Valve (Table D)

mm	Inches	Code	Price
350	14	ECO3303	3,557.30
400	16	ECO3307	3,701.10
450	18	ECO3312	4,152.60
500	20	ECO3315	4,430.10
600	24	ECO3322	5,475.80
660	26	ECO3323	5,944.40
750	30	ECO3325	7,592.90
800	32	ECO3330	8,905.10
900	36	ECO3335	10,683.50

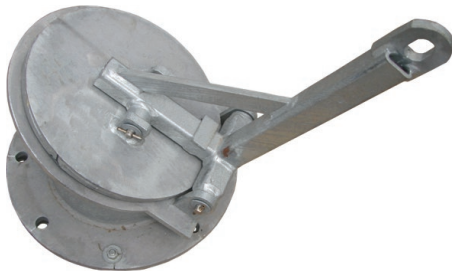

Heavy Duty Flanged (Table D)

mm	Inches	Code	Price
80	3	3267F	664.30
100	4	3275F	685.30
125	5	3277F	924.60
150	6	3285F	927.20
200	8	3287F	1,939.90
250	10	3295F	3,286.30
300	12	3297F	3,615.60
350	14	3303F	4,637.80
375	15	3305F	5,692.30
400	16	3307F	4,908.30
450	18	3312F	5,431.30
500	20	3315F	6,540.30
600	24	3322F	7,215.40
750	30	3325F	10,680.90

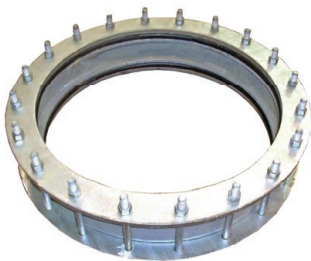

Gibault Joint

mm	to suit OD	Code	Price
300	324	GJ300	1,284.30
400	407	GJ400	2,013.80
500	508	GJ500	2,276.70
600	640	GJ600	2,479.30
660	660	GJ660	2,542.00
750	762	GJ750	2,794.00
900	914	GJ900	6,166.90
1200	1219	GJ1200	10,799.40
1500	1520	GJ1500	7,513.80

STRAINERS



Suction Strainer (Perforated Sheet)

Size							Code	Price
mm	Inches	Mesh size	Open area	Dia.	H			
50	2	6.35x8.89	46%	90	200	7450	205.00	
50	2	6.35x8.89	46%	175	120	7452	231.30	
80	3	9.53x14.47	40%	200	400	7454	352.40	



Hose Tail Strainer

mm	Inches	mesh	Code	Price
50	2	Punched	7265	221.70
80	3	Punched	7285	251.20
100	4	Punched	7295	258.20
125	5	Punched	7305	276.20
150	6	Punched	7315	316.60
200	8	Punched	7325	372.30



Flanged Strainer (Table D)

mm	Inches	mesh	Code	Price
80	3	Punched	7345	246.70
100	4	Punched	7355	267.90
125	5	Punched	7365	278.80
150	6	Punched	7375	357.50
200	8	Punched	7395	395.90
250	10	Weldmesh	7415	1,317.40
300	12	Weldmesh	7425	1,329.60
350	14	Weldmesh	7435	1,566.60



Leaf and Lint Strainers (Table D)

mm	Inches	Code	Price
80	3	7505	4,320.10
100	4	7515	4,440.60
125	5	7525	4,658.50
150	6	7535	5,159.40
200	8	7545	6,285.90



Leaf & Lint Suction Strainers (Table D)

Size	Flow LTR/SEC	Code	Price
LLS-010	10	LLS10	4,674.60
LLS-015	10<15	LLS15	4,355.10
LLS-030	15<30	LLS30	4,798.60
LLS-050	30>50	LLS50	5,146.60
LLS-075	50<75	LLS75	6,155.30
LLS-100	75<100	LLS100	7,730.20
LLS-710	TBA	LLS710	20,510.40

PLEASE NOTE: OUR RANGE OF LEAF & LINT SUCTION STRAINERS ARE NOT PRESSURE RATED.

VALVE SPARES



Gate Check Valve Spare Parts - Spindle Only

mm	Inches	Code	Price
80	3	41004	190.40
100	4	41002	198.50
125	5	41007	198.50
150	6	41006	199.90
200	8	41008	248.70



Gate Check Valve Spare Parts - Donkey Complete

mm	Inches	Code	Price
80	3	DON3	377.50
100	4	DON4	378.70
125	5	DON5	378.70
150	6	DON6	384.50
200	8	DON8	398.40

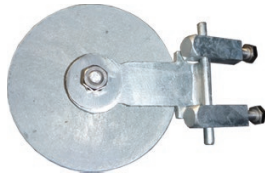

Footvalve Spare Parts - Clack Assembly Complete

mm	Inches	Code	Price
80	3	FCA3	174.80
100	4	FCA4	207.80
125	5	FCA5	221.00
150	6	FCA6	234.20
200	8	FCA8	329.20

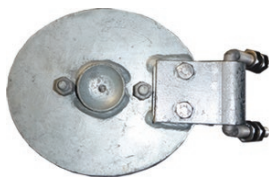

Check Valve Spare Parts - Clack Assembly Complete

mm	Inches	Code	Price
80	3	GVCA3	313.40
100	4	GVCA4	317.80
125	5	GVCA5	331.80
150	6	GVCA6	356.60
200	8	GVCA8	556.40



Suction Strainers - Galvanized

Replacement for Rodney's Footvalve

mm	Inches	Mesh	Code	Price
80	3	Punched	7115	83.20
100	4	Punched	7125	89.80
125	5	Punched	7135	104.30
150	6	Punched	7145	133.40
200	8	Punched	7165	180.70

VALVE SPARES



Suction Strainers - Stainless

Replacement for Rodney's Footvalve

mm	Inches	Mesh	Code	Price
80	3	Punched	7115SS	259.50
100	4	Punched	7125SS	273.70
125	5	Punched	7135SS	298.70
150	6	Punched	7145SS	339.00
200	8	Punched	7165SS316	685.00



Check Valve Clack Rubber

mm	Inches	Code	Price
80	3	11085EPDM	16.30
100	4	11095EPDM	21.10
125	5	11105EPDM	23.40
150	6	11115EPDM	27.70
200	8	11135EPDM	42.10



Footvalve Clack Rubber

mm	Inches	Code	Price
80	3	11235EPDM	12.60
100	4	11245EPDM	18.70
125	5	11255EPDM	21.10
150	6	11265EPDM	25.80
200	8	11285EPDM	30.70
250	10	11305EPDM	46.90
300	12	11315EPDM	60.70
350	14	11325EPDM	66.20
375	15	11335EPDM	98.00
400	16	11345EPDM	104.00
450	18	11355EPDM	108.20
500	20	11365EPDM	113.50
600	24	11375EPDM	152.60
750	30	11385EPDM	234.40



GOOSENECKS & FLANGED PIPE

For range and quality, choose Rodney Industries' Goosenecks and Flanged Pipe.

- Large range of sizes available in both galvanised or polyethylene.
- Non standard lengths available on request.

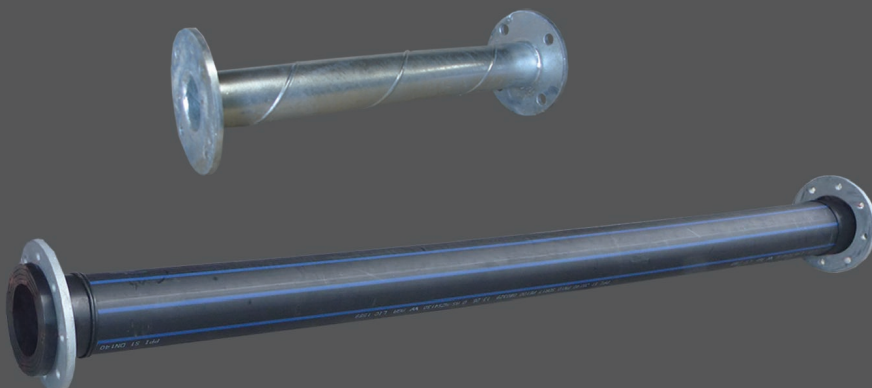

GOOSENECKS



Heavy Duty (Table D)

Degree	Size mm	c/l height mm	Inches	Code	Price
90°	80	600	3	8035	445.30
	100	750	4	8040	504.70
	125	900	5	8045	652.70
	150	900	6	8050	791.10
	200	900	8	8055	1,123.50
45°	80	600	3	8000	485.50
	100	750	4	8005	574.30
	125	900	5	8010	765.00
	150	900	6	8015	828.20
	200	900	8	8020	1,155.50



Goosenecks - Flanged

mm	Size		Code		Price	
	(h)	(l)	SDR17		SDR11	
110	750	980	GN4511017	670.60	GN4511011	691.90
125	900	1150	GN4512517	755.70	GN4512511	780.70
140	900	1150	GN4514017	923.40	GN4514011	975.90
160	900	1200	GN4516017	1,008.40	GN4516011	1,044.70
200	900	1250	GN4520017	1,233.60	GN4520011	1,297.40
225	900	1250	GN4522517	1,360.00	GN4522511	1,433.80
250	1000	1400	GN4525017	2,049.40	GN4525011	2,192.00
280	1000	1400	GN4528017	2,561.10	GN4528011	2,722.50
315	1250	1660	GN4531517	3,056.60	GN4531511	3,351.80



1.6mm Wall Thickness (Table D)

Length	mm	Inches	Code	Price
900mm	100	4	8520	277.40
	125	5	8580	339.10
	150	6	8640	350.50
1800mm	100	4	8530	283.00
	125	5	8590	346.50
	150	6	8650	403.30
2700mm	100	4	8540	327.70
	125	5	8600	403.30
	150	6	8660	472.30
3600mm	100	4	8550	376.10
	125	5	8610	460.20
	150	6	8670	541.80
4500mm	100	4	8560	422.10
	125	5	8620	518.20
	150	6	8680	608.90
5500mm	100	4	8570	472.30
	125	5	8630	581.70
	150	6	8690	686.40

FLANGED PIPE

2.0mm Wall Thickness (Table D)

Length	mm	Inches	Code	Price
900mm	200	8	8880	491.50
	250	10	9000	676.20
	300	12	9055	789.80
	350	14	9170	1,106.70
	375	15	9300P	1,172.10
	400	16	9360	1,238.70
	450	18	9470	1,521.20
18000mm	200	8	8885	612.10
	250	10	9010	826.70
	300	12	9070	984.80
	350	14	9190	1,348.50
	375	15	9310P	1,398.00
	400	16	9370	1,480.00
2700mm	450	18	9490	1,793.00
	200	8	8895	734.00
	250	10	9020	977.10
	300	12	9090	1,180.90
	350	14	9210	1,586.70
	375	15	9320	1,581.00
3600mm	400	16	9390	1,722.50
	450	18	9510	2,065.30
	200	8	8905	854.50
	250	10	9030	1,127.60
	300	12	9110	1,378.40
	350	14	9230	1,824.70
4500mm	375	15	9330	1,834.90
	400	16	9410	1,963.70
	450	18	9530	2,338.40
	200	8	8915	970.80
	250	10	9040	1,278.70
	300	12	9130	1,571.40
5500mm	350	14	9250	2,065.30
	375	15	9340	2,080.00
	400	16	9430	2,087.60
	450	18	9550	2,608.20
	200	8	8925	1,111.80
	250	10	9050	1,448.30
5500mm	300	12	9150	1,789.20
	350	14	9270	2,329.50
	375	15	9350	2,333.90
	400	16	9450	2,475.60
	450	18	9570	2,910.40

4.0mm Wall Thickness (Table D)

Length	mm	Inches	Code	Price
900mm	80	3	8100	235.80
	100	4	8130	277.50
	125	5	8160	393.70
	150	6	8190	436.00
	200	8	8220	590.80
18000mm	80	3	8105	298.70
	100	4	8135	367.70
	125	5	8165	503.70
	150	6	8195	567.20
2700mm	200	8	8225	784.90
	80	3	8110	361.00
	100	4	8140	514.60
	125	5	8170	610.70
3600mm	150	6	8200	699.00
	200	8	8230	952.90
	80	3	8115	424.40
	100	4	8145	605.30
4500mm	125	5	8175	720.20
	150	6	8205	830.80
	200	8	8235	1,119.80
	80	3	8120	488.00
5500mm	100	4	8150	697.80
	125	5	8180	829.60
	150	6	8210	963.20
	200	8	8240	1,288.00
5500mm	80	3	8125	558.10
	100	4	8155	798.20
	125	5	8185	957.80
	150	6	8215	1,109.60
200	8	8245	1,473.60	

FLANGED PIPE



Suction Line - Straight - 6 Mtrs

Size mm	SDR17		SDR11	
	Code	Price	Code	Price
90	FP609017	333.10	FP609011	369.60
110	FP611017	425.00	FP611011	501.60
125	FP612517	540.60	FP612511	604.70
140	FP614017	588.40	FP614011	817.10
160	FP616017	740.50	FP616011	841.00
200	FP620017	1,069.80	FP620011	1,291.00
225	FP622517	1,277.20	FP622511	1,517.30
250	FP625017	1,399.20	FP625011	1,811.50
280	FP628017	1,817.80	FP628011	2,090.60
315	FP631517	1,913.30	FP631511	2,602.20
355	FP635517	2,819.80	FP635511	3,085.00

Suction Line - Straight - 12 Mtrs

Size mm	SDR17		SDR11	
	Code	Price	Code	Price
90	FP1209017	441.20	FP1209011	512.90
110	FP1211017	566.90	FP1211011	719.00
125	FP1212517	711.50	FP1212511	839.80
140	FP1214017	774.40	FP1214011	1,223.20
160	FP1216017	989.30	FP1216011	1,190.40
200	FP1220017	1,496.00	FP1220011	1,938.40
225	FP1222517	1,832.90	FP1222511	2,311.90
250	FP1225017	1,972.40	FP1225011	2,799.60
280	FP1228017	2,701.60	FP1228011	3,248.40
315	FP1231517	2,766.90	FP1231511	4,110.80
355	FP1235517	4,405.00	FP1235511	4,936.70



Suction Line complete with 45° Sweep Bend - 6 Mtrs

Size mm	SDR17		SDR11	
	Code	Price	Code	Price
90	FPS609017	374.20	FPS609011	406.50
110	FPS611017	514.20	FPS611011	611.80
125	FPS612517	694.90	FPS612511	787.40
140	FPS614017	844.20	FPS614011	1,113.40
160	FPS616017	962.40	FPS616011	1,325.30
200	FPS620017	1,408.40	FPS620011	1,717.20
225	FPS622517	1,624.80	FPS622511	1,995.80
250	FPS625017	2,057.20	FPS625011	P.O.A
280	FPS628017	2,411.60	FPS628011	P.O.A
315	FPS631517	2,935.00	FPS631511	P.O.A
355	FPS635517	3,838.50	FPS635511	P.O.A

Suction Line complete with 45° Sweep Bend - 12 Mtrs

Size mm	SDR17		SDR11	
	Code	Price	Code	Price
90	FPS1209017	492.40	FPS1209011	535.30
110	FPS1211017	678.50	FPS1211011	833.60
125	FPS1212517	923.30	FPS1212511	1,051.40
140	FPS1214017	1,106.20	FPS1214011	1,581.30
160	FPS1216017	1,288.90	FPS1216011	1,948.30
200	FPS1220017	1,930.50	FPS1220011	2,448.60
225	FPS1222517	2,269.10	FPS1222511	2,878.10
250	FPS1225017	2,861.70	FPS1225011	P.O.A
280	FPS1228017	3,430.70	FPS1228011	P.O.A
315	FPS1231517	4,236.50	FPS1231511	P.O.A
355	FPS1235517	5,489.70	FPS1235511	P.O.A



GALVANISED, STAINLESS & ALUMINIUM FITTINGS

*For range and quality, choose
Rodney Industries' fittings*

- Large range available including, bends, tees, tapers, joiners
- We can modify most fittings to suit your requirements

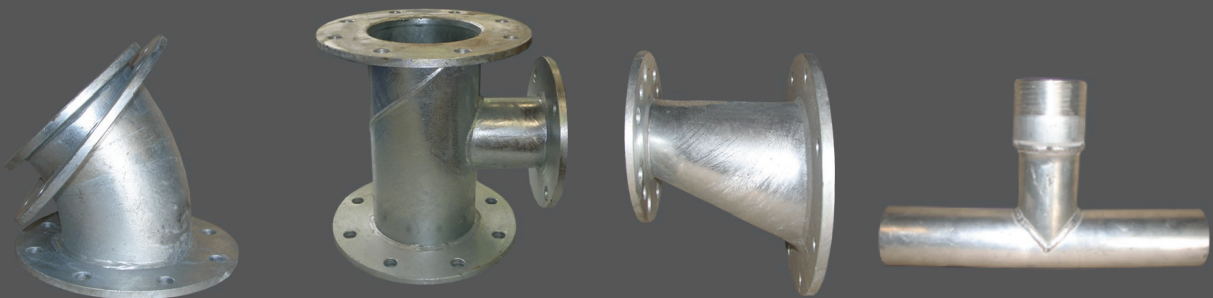

BENDS



General Purpose 4mm Fixed Flange (Table D)

mm	Inches	Code	Price
80	3	1730	86.00
100	4	1735	127.10
125	5	1740	214.80
150	6	1750	234.70
200	8	1770	459.70



General Purpose 4mm Loose Flange (Table D)

mm	Inches	Code	Price
80	3	2050	93.00
100	4	2060	134.70
125	5	2070	224.50
150	6	2080	248.10
200	8	2100	475.80

Heavy Duty min. 5mm Fixed Flange (Table D)

HEAVY DUTY	mm	Inches	Code	Price
	80	3	1731	261.30
	100	4	1736	224.30
	125	5	1741	305.90
	150	6	1751	297.10
	200	8	1771	562.70
	250	10	1791	834.10
	300	12	1801	1,078.80

Heavy Duty min. 5mm Loose Flange (Table D)

HEAVY DUTY	mm	Inches	Code	Price
	80	3	2051	292.50
	100	4	2061	262.60
	125	5	2071	348.00
	150	6	2081	362.50
	200	8	2101	650.60
	250	10	2121	989.60
	300	12	2131	1,257.30



General Purpose 4mm Fixed Flange (Table D)

mm	Inches	Code	Price
80	3	1885	101.40
100	4	1890	151.90
125	5	1900	188.50
150	6	1910	312.90
200	8	1930	563.70



General Purpose 4mm Loose Flange (Table D)

mm	Inches	Code	Price
80	3	2225	107.10
100	4	2230	142.40
125	5	2240	224.50
150	6	2250	291.70
200	8	2270	580.30

Heavy Duty min. 5mm Fixed Flange (Table D)

HEAVY DUTY	mm	Inches	Code	Price
	80	3	1886	175.40
	100	4	1891	203.40
	125	5	1901	271.30
	150	6	1911	310.70
	200	8	1931	588.70
	250	10	1951	884.90
	300	12	1961	1,165.30

Heavy Duty min. 5mm Loose Flange (Table D)

HEAVY DUTY	mm	Inches	Code	Price
	80	3	2226	206.30
	100	4	2231	239.10
	125	5	2241	313.80
	150	6	2251	372.70
	200	8	2271	668.80
	250	10	2291	1,034.20
	300	12	2301	1,336.40

BENDS



2mm Light Wall Fixed Flange (Table D)

mm	Inches	Code	Price
225	9	1780	879.70
250	10	1790	1,091.40
300	12	1800	1,232.50
350	14	1810	1,769.20
375	15	1820	1,762.10
400	16	1830	1,898.10
450	18	1840	2,210.40



2mm Light Wall Fixed Flange (Table D)

mm	Inches	Code	Price
225	9	2110	938.70
250	10	2120	1,220.30
300	12	2130	1,286.30
350	14	2140	1,928.80
375	15	2150	1,866.70
400	16	2160	2,053.30
450	18	2170	2,613.00



2mm Light Wall Fixed Flange (Table D)

mm	Inches	Code	Price
225	9	1940	1,091.40
250	10	1950	1,419.00
300	12	1960	1,562.60
350	14	1970	2,248.20
375	15	1980	2,161.00
400	16	1990	2,331.40
450	18	2000	2,705.30



2mm Light Wall Fixed Flange (Table D)

mm	Inches	Code	Price
225	9	2280	1,142.70
250	10	2290	1,526.70
300	12	2300	1,757.00
350	14	2310	2,409.00
375	15	2320	2,244.30
400	16	2330	2,986.90
450	18	2340	3,110.60

BENDS AND TEES



* Denotes Lobster Back Style 2mm Wall

Medium Wall Loose Flange 90°

mm	Inches	Code	Price
80-40	3-1½	2380S	436.10
80-50	3-2	2385S	417.50
80-65	3-2½	2390S	500.80
100-40	4-1½	2410S	475.20
100-50	4-2	2420S	487.90
100-65	4-2½	2430S	525.80
100-80	4-3	2440S	540.00
125-65	5-2½	2450S	536.70
125-80	5-3	2460S	577.20
125-100	5-4	2465S	566.20
150-65	6-2½	2470S	639.30
150-80	6-3	2475S	674.00
150-100	6-4	2480S	710.40
150-125	6-5	2490S	689.30
200-125	8-5	2530S	859.90
200-150	8-6	2540S	796.50
250-150*	10-6*	2590S	1,186.30
250-200*	10-8*	2600S	1,581.40



1.6mm Light Wall (Table D)

mm	Inches	Code	Price
80-50	3-2 branch	6130	397.00
80-80	3-3	6135	394.40
100-80	4-3 branch	6140	428.30
100-100	4-4	6145	436.60
125-100	5-4 branch	6150	490.10
125-125	5-5	6155	522.10
150-100	6-4 branch	6160	537.50
150-150	6- 6	6165	550.80
200-150	8-6 branch	6170	691.90
200-200	8- 8	6175	761.40
250-250	10-10	6195	1,265.00
300-300	12-12	6205	1,420.80

Heavy Duty (Table D)

mm	Inches	Code	Price
80-80	3	6136	402.10
100-100	4	6146	476.20
125-125	5	6156	580.10
150-150	6	6166	702.10
200-200	8	6176	933.20
250-250	10	6196	1,279.10
300-300	12	6206	1,653.70
350-350	14	6219	3,066.20

TAPERS CONCENTRIC



Light Wall (Table D)

mm	Inches	Code	Price	Code with socket	Price
32-50	1¼-2	4985	212.40	4985S	299.20
32-80	1¼-3	4995	215.00	4995S	301.80
40-50	1½-2	5005	227.90	5005S	P.O.A
40-65	1½-2½	5015	314.50	5015S	P.O.A
40-80	1½-3	5025	231.60	5025S	318.90
40-100	1½-4	5035	243.30	5035S	330.60
50-65	2-2½	5075	245.90	5075S	P.O.A
50-80	2-3	5045	370.30	5045S	457.60
50-100	2-4	5055	250.40	5055S	337.00
50-125	2-5	5065	275.30	5065S	P.O.A
65-80	2½-3	5085	236.10	5085S	322.90
65-100	2½-4	5095	247.10	5095S	334.40
65-125	2½-5	5105	270.90	5105S	358.10
65-150	2½-6	5115	289.60	5115S	376.70
80-100	3-4	5125	284.40	5125S	370.30
80-125	3-5	5135	308.10	5135S	394.10
80-150	3-6	5145	326.70	5145S	414.00
80-200	3-8	5155	330.60	5155S	416.50
100-125	4-5	5165	260.00	5165S	346.60
100-150	4-6	5175	274.10	5175S	360.80
100-175	4-7	5185	318.90	5185S	P.O.A
100-200	4-8	5195	341.50	5195S	428.10
100-225	4-9	5205	403.10	5205S	P.O.A
125-150	5-6	5215	270.90	5215S	358.10
125-175	5-7	5285	328.60	5285S	P.O.A
125-200	5-8	5225	350.50	5225S	437.80
125-225	5-9	5235	419.10	5235S	P.O.A
125-250	5-10	5245	446.80	5245S	P.O.A
150-200	6-8	5255	359.50	5255S	446.80
150-225	6-9	5265	432.60	5265S	P.O.A
150-250	6-10	5275	498.00	5275S	P.O.A
175-200	7-8	5305	411.40	5305S	P.O.A
200-225	8-9	5315	488.40	5315S	P.O.A
200-250	8-10	5325	559.70	5325S	P.O.A
200-300	8-12	5335	628.40	5335S	P.O.A
250-300	10-12	5375	663.70	5375S	P.O.A



SGP General Purpose - 4mm Wall (min.) (Table D)

mm	Inches	Code	Price	Code with socket	Price
50-80	2-3	5045GP	110.10	5045GPS	137.00
50-100	2-4	5055GP	144.90	5055GPS	176.80
65-80	2½-3	5085GP	111.30	5085GPS	142.50
65-100	2½-4	5095GP	144.90	5095GPS	175.60
65-125	2½-5	5105GP	203.60	5105GPS	P.O.A
65-150	2½-6	5115GP	228.10	5115GPS	258.20
80-100	3-4	5125GP	146.20	5125GPS	176.80
80-125	3-5	5135GP	204.90	5135GPS	235.50
80-150	3-6	5145GP	225.10	5145GPS	256.90
100-125	4-5	5165GP	204.90	5165GPS	P.O.A
100-150	4-6	5175GP	241.00	5175GPS	273.40
100-200	4-8	5195GP	353.00	5195GPS	385.50
125-150	5-6	5215GP	239.80	5215GPS	272.20
125-200	5-8	5225GP	342.60	5225GPS	374.30
150-200	6-8	5255GP	350.50	5255GPS	381.70



Heavy Duty - 5mm Wall (min.) (Table D)

	mm	inch	Code	Price	Code with socket	Price
	HEAVY DUTY	65-100	2½-4	5097	224.20	5097S
	80-100	3-4	5127	240.30	5127S	P.O.A
	80-150	3-6	5147	261.40	5147S	274.80
	100-125	4-5	5167	283.90	5167S	301.70
	100-150	4-6	5177	318.30	5177S	330.00
	125-150	5-6	5217	332.60	5217S	364.50
	125-200	5-8	5227	454.20	5227S	455.60
	150-200	6-8	5257	480.50	5257S	535.00
	200-250	8-10	5327	718.10	5327S	613.80
	250-300	10-12	5377	975.70	5377S	P.O.A

TAPERS ECCENTRIC



Light Wall (Table D)

mm	Inches	Code	Price	Code with socket	Price
32-50	1¼-2	5645	215.50	5645S	P.O.A
32-80	1¼-3	5655	185.80	5655S	P.O.A
40-50	1½-2	5665	228.40	5665S	P.O.A
40-65	1½-2½	5675	232.20	5675S	P.O.A
40-80	1½-3	5685	361.60	5685S	P.O.A
40-100	1½-4	5695	245.10	5695S	P.O.A
50-65	2-2½	5730	257.30	5730S	P.O.A
50-80	2-3	5710	241.30	5710S	327.40
50-100	2-4	5715	251.00	5715S	337.70
50-125	2-5	5720	314.00	5720S	401.50
65-80	2½-3	5725	236.70	5725S	323.70
65-100	2½-4	5735	247.70	5735S	335.20
65-125	2½-5	5740	271.50	5740S	358.90
65-150	2½-6	5745	288.80	5745S	376.30
80-100	3-4	5750	285.10	5750S	371.20
80-125	3-5	5755	310.10	5755S	396.30
80-150	3-6	5760	327.40	5760S	414.90
80-200	3-8	5765	387.40	5765S	474.10
100-125	4-5	5770	260.60	5770S	347.40
100-150	4-6	5775	274.70	5775S	361.60
100-175	4-7	5780	319.70	5780S	P.O.A
100-200	4-8	5785	342.20	5785S	429.10
100-225	4-9	5790	404.10	5790S	P.O.A
125-150	5-6	5795	271.50	5795S	358.90
125-175	5-7	5845	329.30	5845S	P.O.A
125-200	5-8	5800	351.30	5800S	438.80
125-225	5-9	5805	420.10	5805S	P.O.A
125-250	5-10	5810	447.80	5810S	534.00
150-200	6-8	5815	360.30	5815S	447.80
150-225	6-9	5825	433.60	5825S	P.O.A
150-250	6-10	5835	499.20	5835S	586.70
175-200	7-8	5865	412.30	5865S	P.O.A
200-225	8-9	5875	489.50	5875S	P.O.A
200-250	8-10	5895	561.00	5895S	647.80
200-300	8-12	5905	629.90	5905S	717.40
250-300	10-12	5945	722.40	5945S	809.90



SGP General Purpose - 4mm Wall (min.) (Table D)

mm	Inches	Code	Price	Code with socket	Price
50-80	2-3	5710GP	114.40	5710GPS	174.30
50-100	2-4	5715GP	148.70	5715GPS	176.80
65-80	2½-3	5725GP	114.40	5725GPS	174.30
65-100	2½-4	5735GP	148.70	5735GPS	176.80
65-125	2½-5	5740GP	189.00	5740GPS	217.20
65-150	2½-6	5745GP	241.00	5745GPS	271.00
80-100	3-4	5750GP	149.90	5750GPS	178.10
80-125	3-5	5755GP	190.30	5755GPS	218.40
80-150	3-6	5760GP	236.80	5760GPS	266.20
100-125	4-5	5770GP	211.80	5770GPS	239.80
100-150	4-6	5775GP	252.10	5775GPS	279.50
100-200	4-8	5785GP	370.70	5785GPS	399.50
125-150	5-6	5795GP	247.70	5795GPS	275.90
125-200	5-8	5800GP	360.20	5800GPS	387.90
150-200	6-8	5815GP	365.20	5815GPS	393.40



Heavy Duty - 5mm Wall (min.) (Table D)

	mm	Inches	Code	Price	Code with socket	Price
HEAVY DUTY	65-100	2½-4	5733	227.50	5733S	310.10
	80-100	3-4	5753	244.00	5753S	310.10
	80-150	3-6	5763	264.60	5763S	310.70
	100-125	4-5	5773	285.00	5773S	321.70
	100-150	4-6	5778	322.30	5778S	333.10
	125-150	5-6	5798	336.30	5798S	346.00
	125-200	5-8	5803	459.30	5803S	540.70
	150-200	6-8	5818	483.10	5818S	483.10
	200-250	8-10	5898	731.00	5898S	739.30
	250-300	10-12	5948	934.10	5948S	P.O.A

ACCESSORIES



Flange Support Bracket

mm	Inches	Code	Price
50	2	FSB2	16.60
80	3	FSB3	25.50
100	4	FSB4	27.70
125	5	FSB5	29.80
150	6	FSB6	29.80
200	8	FSB8	31.90
225	9	FSB9	23.50
250	10	FSB10	71.90
300	12	FSB12	78.30
350	14	FSB14	98.70
375	15	FSB15	136.90
400	16	FSB16	144.60
450*	18*	FSB18	174.30
500*	20*	FSB20	168.30
600*	24*	FSB24	201.60



* Denotes different style for larger brackets.



Adjustable Flange Support Bracket

mm	Inches	Code	Price
80	3	FSB3A	74.00
100	4	FSB4A	74.00
125	5	FSB5A	74.00
150	6	FSB6A	74.00
200	8	FSB8A	74.00



Bore Caps

mm	OD	Size		Code	Price
		Thickness	Slot		
32	230	8	55 x 25W	4200	86.80
40	230	8	55 x 25W	4201	91.10
50	230	8	55 x 25W	4202	93.00
65	230	8	55 x 25W	4203	101.10
80	285	10	70 x 25W	4204	124.50
100	285	10	70 x 25W	4206	140.80



Bore Caps Stainless Steel

mm	OD	Size		Code	Price
		Thickness	Slot		
32	230	8	55 x 25W	4200SS316	208.30
40	230	8	55 x 25W	4201SS316	221.40
50	230	8	55 x 25W	4202SS316	249.00
65	230	8	55 x 25W	4203SS316	262.20
80	285	10	70 x 25W	4204SS316	385.50
100	285	10	70 x 25W	4206SS316	441.70



Bore Caps - Dual FBSP to suit Deep Well Pump

mm	Code	Price
32mm x 40mm	4210G	152.80
40mm x 50mm	4207G	289.70

FLANGES AND GASKETS



Weld On Galv (Table D)

mm	Inches	Thickness	Code	Price
50	2	10	10495	24.90
65	2½	10	10505	27.40
80	3	10	10515	30.00
100	4	10	10525	43.30
125	5	10	10535	54.70
150	6	10	10545	63.10
175	7	10	10555	81.50
200	8	12	10565	102.40
225	9	12	10575	126.20
250	10	12	10585	147.10
300	12	12	10595	160.40
350	14	16	10605	270.00
375	15	16	10615	289.70
400	16	16	10625	310.70
450	18	20	10635	456.50
500	20	20	10645	643.00
600	24	20	10655	691.30
750	30	20	10665	1,186.70
900	36	20	10675	1,324.30

Blank Galv

mm	Inches	Thickness	Code	Price
50	2	10	10497	43.30
65	2½	10	10507	46.50
80	3	10	10517	48.40
100	4	10	10527	49.70
125	5	10	10537	56.10
150	6	10	10547	93.60
200	8	12	10567	113.40
250	10	12	10587	159.20
300	12	12	10597	179.60
350	14	16	10607	313.30
375	15	16	10617	350.20
400	16	16	10627	277.00
450	18	20	10637	516.30
500	20	20	10647	620.80
600	24	20	10657	814.30
750	30	20	10667	P.O.A
900	36	20	10677	P.O.A



Rubber Gaskets

mm	Size		Code	Price
	Inches			
40	1½		11395	5.30
50	2		11405	5.30
65	2½		11415	5.30
80	3		11425	6.30
100	4		11435	6.30
125	5		11445	7.40
150	6		11455	7.40
175	7		11465	10.00
200	8		11475	10.00
225	9		11485	10.00

Rubber Gaskets

mm	Size		Code	Price
	Inches			
250	10		11495	12.10
300	12		11505	13.10
350	14		11515	15.20
375	15		11525	21.50
400	16		11535	22.60
450	18		11545	22.60
500	20		11555	30.50
600	24		11565	42.00
750	30		11575	57.80
900	36		11585	72.50

CONNECTORS



Threaded - Hose Ends

mm	Inches	Code	Price
80-50 BSP	3-2	4716	106.10
80-80 BSP	3-3	4726	117.50
100-80 BSP	4-3	4736	129.60
100-100 BSP	4-4	4746	132.10
125-125 BSP	5-5	4756	157.00
150-150 BSP	6-6	4766	218.50



To Hose (Two Beads)

mm	Inches	Code	Price
50	2	3060B2	30.10
65	2½	3070B2	35.80
80	3	3080B2	51.10
100	4	3090B2	77.30
125	5	4000B2	97.10
150	6	4010B2	113.80



Flanged & Threaded BSP (Table D)

mm	Inches	Code	Price
65-65 BSP	2½-2½ BSP	3795	141.00
80-80 BSP	3-3 BSP	3805	143.00
100-100 BSP	4-4 BSP	3815	151.30
125-125 BSP	5-5 BSP	3825	175.10
150-80 BSP	6-3 BSP	4265	273.00
150-125 BSP	6-5 BSP	4285	321.30
150-150 BSP	6-6 BSP	3835	222.80



Enlarging Flanged & Threaded BSP (Table D)

mm	Inches	Code	Price
50-80 BSP	2-3 BSP	3875	222.80
50-100 BSP	2-4 BSP	3885	233.70
65-80 BSP	2½-3 BSP	3920	228.60
80-100 BSP	3-4 BSP	3930	224.10
100-125 BSP	4-5 BSP	3945	236.90
100-150 BSP	4-6 BSP	3950	276.10
125-150 BSP	5-6 BSP	3955	289.00



Reducing Flanged & Threaded BSP (Table D)

mm	Inches	Code	Price
65-50 BSP	2½-2 BSP	4165	151.30
80-50 BSP	3-2 BSP	4185	211.20
100-50 BSP	4-2 BSP	4215	221.50
100-80 BSP	4-3 BSP	4235	221.50
125-80 BSP	5-3 BSP	4245	259.50
125-100 BSP	5-4 BSP	4255	273.00
150-100 BSP	6-4 BSP	4275	287.90

FLANGED CONNECTORS



1.6mm Wall Thickness (Table D)

Length	mm	Inches	Code	Price
300mm	80	3	3600	187.40
	100	4	3610	206.40
	125	5	3620	249.10
	150	6	3630	287.00
	200	8	3650	397.50
	250	10	3670	556.80
	300	12	3680	621.50
600mm	80	3	3605	196.60
	100	4	3615	220.40
	125	5	3625	266.70
	150	6	3635	308.30
	200	8	3655	434.10
	250	10	3675	603.20
	300	12	3685	681.90

4mm min. Wall Thickness (Table D)

Length	mm	Inches	Code	Price
300mm	80	3	3601	188.60
	100	4	3611	214.90
	125	5	3621	284.50
	150	6	3631	304.70
	200	8	3651	532.30
	250	10	3671	624.50
	300	12	3681	636.20
600mm	80	3	3606	207.60
	100	4	3616	246.00
	125	5	3626	320.50
	150	6	3636	346.20
	200	8	3656	570.90
	250	10	3676	864.50
	300	12	3686	1,072.60

HEAVY DUTY

FLANGED HOSE ENDS

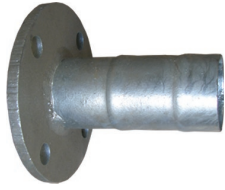

STRAIGHT: 1.6mm Wall Light Duty (Table D)

mm	inch	Code	Price
80	3	4356	82.80
100	4	4366	94.20
125	5	4376	121.50
150	6	4386	142.60
200	8	4406	153.30
250	10	4426	217.70
300	12	4436	479.90



REDUCING: 1.6mm Wall Light Duty (Table D)

mm	Inches	Code	Price
80- 50	3-2	4786	87.90
100- 50	4-2	4796	170.60
100- 80	4-3	4806	174.30
125- 80	5-3	4816	201.70
125-100	5-4	4826	178.20
150- 80	6-3	4986	196.60
150-100	6-4	4836	310.60
150-125	6-5	4846	213.20
200-100	8-4	4856	287.10
200-150	8-6	4866	368.60

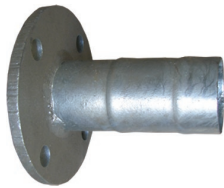

ECCENTRIC: 1.6mm Wall Light Duty (Table D)

mm	Inches	Code	Price
80-100	3-4	4547	249.50
80-125	3-5	4557	242.40
80-150	3-6	4567	290.80
100-125	4-5	4577	282.00
100-150	4-6	4587	311.90
125-150	5-6	4597	306.80



ENLARGING: 1.6mm Wall Light Duty (Table D)

mm	Inches	Code	Price
50- 80	2-3	4546	102.40
50-100	2-4	4556	233.00
65- 80	2½ -3	4566	117.70
65-100	2½ -4	4576	231.10
80-100	3-4	4586	152.20
80-125	3-5	4596	242.40
80-150	3-6	4606	256.50
100-125	4-5	4616	205.00
100-150	4-6	4626	374.80
125-150	5-6	4636	179.50
200-250	8-10	4656	377.40

HOSE JOINERS, TAILS AND CLAMPS



**HOSE JOINER - Single Bead to Each End:
MIN 1.6mm Wall Light Duty**

mm	Inches	Code	Price
50	2	3060	35.80
65	2½	3070	38.30
80	3	3080	40.90
100	4	3090	44.80
125	5	4000	74.70
150	6	4010	94.60
200	8	4020	134.10



Machined – Suit Standard Layflat Hose

mm	Inches	Code	Price
110	4	4978	297.80
114	4½	4980	313.20
125	5	4982	320.20
150	6	4984	362.10



HEAVY DUTY HOSE JOINER (MACHINED) (Table D)

mm	Inches	Code	Price
80	3	3080HD	139.90
100	4	3090HD	198.70
125	5	4000HD	310.40
150	6	4010HD	380.00



Standard Stainless Steel

mm	Inches	Code	Price
100	4	4905SS	49.00
125	5	4915SS	50.30
150	6	4925SS	51.60
200	8	4945SS	52.80



HEAVY DUTY HOSE TAIL (MACHINED)

mm	Inches	Code	Price
80	3	4356HD	149.60
100	4	4366HD	191.00
125	5	4376HD	271.80
150	6	4386HD	335.40
200	8	4406HD	785.40
250	10	4426HD	1,139.30



Standard Galvanized Steel

mm	Inches	Code	Price
80	3	4895G	28.60
100	4	4905G	31.20
125	5	4915G	33.70
150	6	4925G	35.60
200	8	4945G	39.60

REDUCERS AND TEES



Standard

mm	inch	Code	Price
80-50	3-2	495	63.20
100-50	4-2	515	64.40
100-80	4-3	525	73.70
125-80	5-3	535	107.60
125-100	5-4	545	80.70
150-125	6-5	555	84.20
150-100	6-4	565	212.80



Special - To Suit Irrigation Hose

mm	inch	Code	Price
80-65	3-2 1/2	496	163.70
100-89	4-3 1/2	526	177.70
125-89	5-3 1/2	536	263.10
125-114	5-4 1/2	546	194.00



Standard

mm	inch	Code	Price
50	2	25	59.60
80	3	35	67.80
100	4	45	84.20
125	5	55	91.20
150	6	65	133.30



Single Reducing

mm	inch	Code	Price
80-80-50	3-3-2	95	66.60
100-100-50	4-4-2	105	70.10
100-100-80	4-4-3	115	77.10
125-125-50	5-5-2	125	86.60
125-125-100	5-5-4	135	95.90
150-150-125	6-6-5	145	126.20



Double Reducing

mm	inch	Code	Price
80-50-50	3-2-2	155	120.50
100-50-50	4-2-2	165	123.90
100-80-80	4-3-3	175	133.30
125-100-100	5-4-4	185	143.80
150-125-125	6-5-5	195	163.70



Threaded Branch

mm	inch	Code	Price
50-50-50	2-2-2	235	79.50
80-80-50	3-3-2	240	87.70
80-80-80	3-3-3	245	102.90
80-80-100	3-3-4	265	194.00
100-100-50	4-4-2	275	97.10
100-100-80	4-4-3	285	107.60
100-100-100	4-4-4	295	111.10
125-125-50	5-5-2	305	119.30
150-150-100	6-6-4	315	150.80

CROSSES



Standard

mm	inch	Code	Price
50	2	325	66.60
80	3	335	72.50
100	4	345	90.00
125	5	355	116.90
150	6	365	167.20

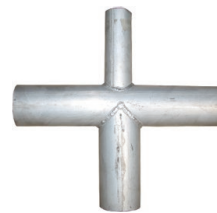

Single Reducing

mm	inch	Code	Price
80-80-80-50	3-3-3-2	375	83.00
100-100-100-80	4-4-4-3	385	106.40
125-125-125-100	5-5-5-4	395	131.00
150-150-150-125	6-6-6-5	405	169.50



Double Reducing

mm	inch	Code	Price
80-80-50-50	3-3-2-2	415	70.10
100-100-50-50	4-4-2-2	425	84.20
100-100-80-80	4-4-3-3	435	86.60
125-125-100-100	5-5-4-4	445	111.10
150-150-125-125	6-6-5-5	455	161.30

BENDS

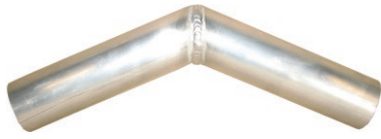

Standard 45°

mm	Inches	Code	Price
50	2	795	46.80
80	3	810	49.10
100	4	815	63.20
125	5	820	77.10
150	6	825	104.00



Standard 90°

mm	Inches	Code	Price
50	2	675	49.10
80	3	685	56.10
100	4	695	66.60
125	5	705	79.50
150	6	715	106.40



Reducing 45°

mm	Inches	Code	Price
80-50	3-2	845	102.90
100-80	4-3	855	123.90
125-100	5-4	865	142.70
150-125	6-5	875	166.00



Reducing 90°

mm	Inches	Code	Price
80-50	3-2	745	129.80
100-50	4-2	755	147.30
100-80	4-3	765	156.70
150-100	6-4	775	350.70
125-100	5-4	780	169.60
150-125	6-5	785	203.50

STARTERS AND ENDS



BSP Starter

mm	Inches	Code	Price
50-40 BSP	2-1½	1125	39.80
50-50 BSP	2-2	1135	46.80
50-80 BSP	2-3	1145	56.10
80-40 BSP	3-1½	1165	59.60
80-50 BSP	3-2	1175	64.40
80-65 BSP	3-2½	1185	72.50
80-80 BSP	3-3	1190	73.70
80-100 BSP	3-4	1195	87.70
100-40 BSP	4-1½	1205	79.50
100-50 BSP	4-2	1215	91.20
100-65 BSP	4-2½	1225	79.50
100-80 BSP	4-3	1235	87.70
100-100 BSP	4-4	1245	90.00



Stop Ends

mm	Inches	Code	Price
50	2	975	23.40
80	3	985	33.90
100	4	995	37.40
125	5	1005	50.30
150	6	1010	67.80



Hose Joiner (Bead Each End)

mm	Inches	Code	Price
50	2	1035BEE	21.00
80	3	1045BEE	21.00
100	4	1055BEE	30.40
125	5	1065BEE	36.30
150	6	1075BEE	46.80



Hose Ends

mm	Inches	Code	Price
50	2	1035	19.80
80	3	1045	19.80
100	4	1055	25.70
125	5	1065	29.30
150	6	1075	37.40



FLOATS & PONTOONS

With a large selection of standard sizes available, Rodney Industries' offers an Australian Made floats and pontoons designed for Australian conditions. If standard doesn't suit your requirements, don't worry - our Sales and Design Team can help!

Features of our Floats and Pontoons Include:

- Designs include single or double style.
- Variations on standard sizes available.
- All tethering lugs have metal ferrules to prevent cable cutting/sawing.
- Adjustable sled to the batter angle (slope angle) of ponds, dams, rivers.
- Configured for suction line, footvalves or submersible pumps.

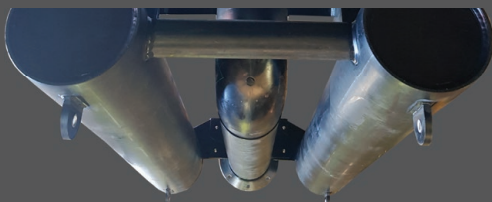

FLOATS & PONTOONS



Floats - Single

DIA	Size		Code	Price
	Length	Load Capacity		
160	1500	15 kg	F1601500	442.80
200	1000	15 kg	F2001000	497.90
200	1500	21 kg	F2001500	510.70
200	2000	29 kg	F2002000	524.80
250	1500	34 kg	F2501500	608.00
315	1500	53 kg	F3151500	733.40
315	2000	71 kg	F3152000	802.50
315	2500	89 kg	F3152500	835.80
315	3000	106 kg	F3153000	869.10
355	2500	112 kg	F3552500	1,196.70
355	3000	135kg	F3553000	1,249.20

Floats - Double

DIA	Size		Code	Price
	Length	Load Capacity		
200	1500	43kg	FD2001500	1,583.20
200	2000	57kg	FD2002000	2,645.50
250	2500	111 kg	FD2502500	2,725.00
250	3000	134 kg	FD2503000	2,794.10
315	2500	177 kg	FD3152500	3,334.20
315	3000	250 kg	FD3153000	3,403.30
355	2500	225 kg	FD3552500	4,061.20
355	3000	269 kg	FD3553000	4,199.40
400	2500	285 kg	FD4002500	4,966.10
450	3000	433 kg	FD4503000	5,832.50



*Five lugs included on 160mm floats

OUR 'FAB' CREATIONS

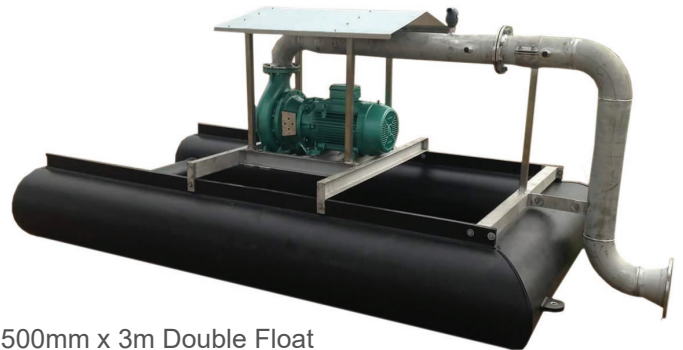

500mm x 3m Double Float



630mm x 4.5m Double Float



Poly Pontoon with Galv Support Frame



PUMP PONTOONS

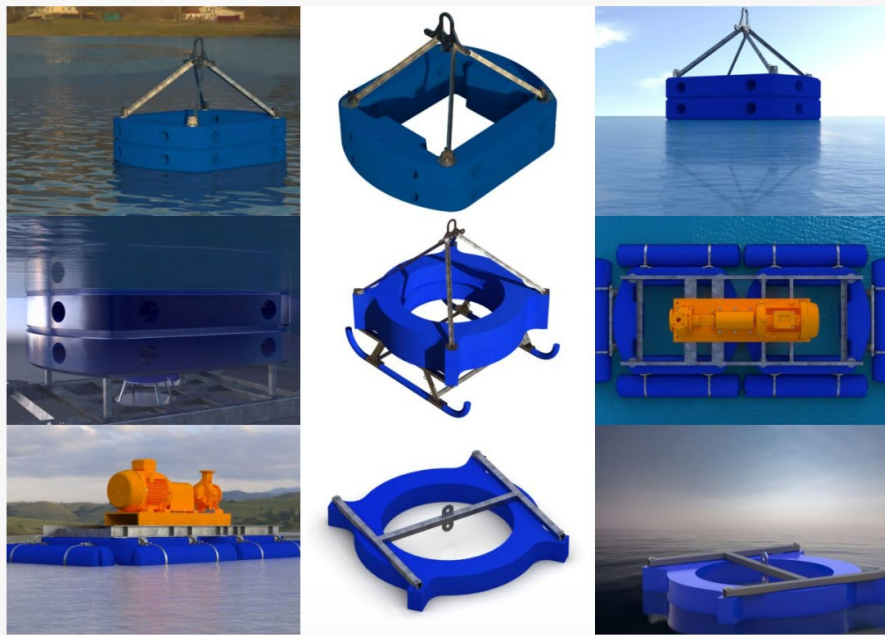

HASSLE FREE PUMP HANDLING & PROTECTION

Built from the ground up to be the most adaptable, unmanned floating structures. All of the UAT modular flotation systems support an enormous range of pumps (up to 5 tonne).

Multiple configurations are available with all designs being immensely robust. With the ability to package down into an extremely compact form factor, moving and storing the units is particularly easy. UAT's interchangeable component design will allow you to customise and grow your structure to suit your future needs.

Custom built for both submersible and surface pumps, these pump floats are made to last.

Complete protection for all of your pumps:

- Tough and durable
- A truly modular concept – all modules are interchangeable in a 'snap together' configuration
- Chemical resistant construction
- Handling advantages and options include Crane, Dozer, Excavator, Truck, Trailer, Workshop
- Efficient storage (small footprint and stackable)
- Easy to handle and manoeuvre

WHO IS IT FOR?

With proven designs to safely and easily position, handle and manoeuvre submersible pumps from 50kg to 5,000kg, we protect your most valuable assets.

For use in:

- Mining
- Utilities and Wastewater Treatment Plants
- Wastewater Ponds, Lagoons and Tanks
- Agribusiness, Feedlots, Piggeries, Dairies
- Abattoirs
- Heavy Industry
- Refineries
- Oil and Gas
- Recreational Water Bodies, Parks and Lakes
- Industry, Pulp and Paper Mills, Starch Factories

PUMP PONTOONS



Example Image*	Max Pump Weight (Kg)	Pontoon Assembled Weight Excluding Pump (Kg)	Assembled Dimensions L x W x H	Filling	Code	List Price
	180	95	1916 x 1874 x 1341	Non Foam Filled	SK-300-A	\$4,900
	120	161	2390 x 1874 x 1847	Non Foam Filled	SK-300-AS	\$7,500
	450	148	1916 x 1874 x 1602	Non Foam Filled	SK-600-A	\$7,300
	400	214	2390 x 1874 x 2109	Non Foam Filled	SK-600-AS	\$8,900
	1800	467	2700 x 2260 x 2047	Non Foam Filled	SK-2000-A	\$13,200
	1400	750	2796 x 2260 x 3070	Non Foam Filled	SK-2000-AS	\$22,500
	1800	467	2700 x 2260 x 2047	Foam Filled	SK-2000-A-FF	\$17,000
	1400	750	2796 x 2260 x 3070	Foam Filled	SK-2000-AS-L-FF	\$26,000

* Actual colour will be blue



POLYETHYLENE FITTINGS

*For range and quality, choose
Rodney Industries' fittings*

We offer a large selection of polyethylene fittings including:

- Bends
- Tees
- Elbows
- Stub Flanges
- Reducers

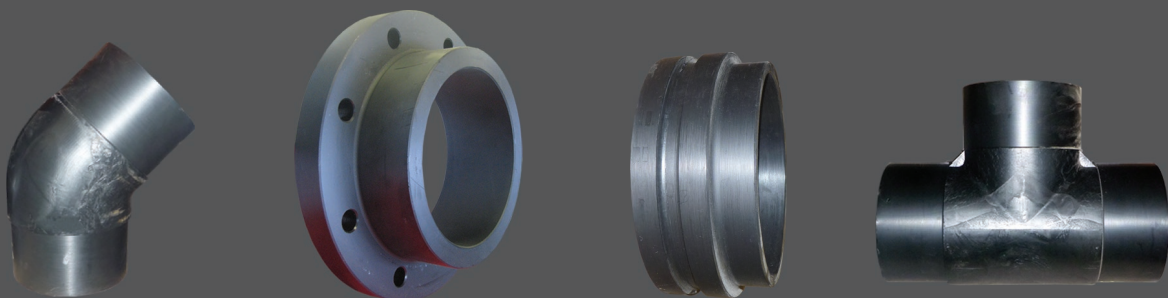

SEGMENTED BENDS

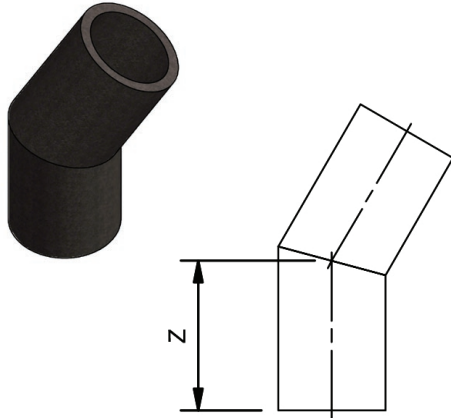

Segmented Bends - 30°

Size		Code	Price	Code	Price
DN	Z	SDR17		SDR11	
250	350	SEG2503017	363.60	SEG2503011	419.10
280	363	SEG2803017	414.70	SEG2803011	491.70
315	428	SEG3153017	499.00	SEG3153011	607.40
355	443	SEG3553017	588.50	SEG3553011	729.10
400	461	SEG4003017	744.80	SEG4003011	930.50
450	481	SEG4503017	944.20	SEG4503011	1,189.50
500	551	SEG5003017	1,189.50	SEG5003011	1,541.20
560	575	SEG5603017	1,422.90	SEG5603011	1,881.20
630	660	SEG6303017	1,814.60	SEG6303011	2,442.30
710	635	SEG7103017	P.O.A	SEG7103011	P.O.A
800	671	SEG8003017	P.O.A	SEG8003011	P.O.A

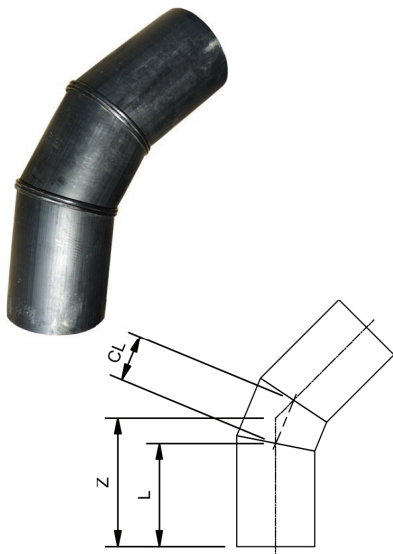

Segmented Bends - 45°

Size		Code		Price	Code		Price
DN	Z	L	CL	SDR17	SDR11		
250	412	330	150	SEG2504517	618.60	SEG2504511	687.30
280	474	383	167	SEG2804517	950.10	SEG2804511	1,037.10
315	498	395	190	SEG3154517	1,101.80	SEG3154511	1,234.00
355	520	406	211	SEG3554517	1,267.30	SEG3554511	1,483.10
400	548	420	238	SEG4004517	1,581.20	SEG4004511	1,815.80
450	580	435	270	SEG4504517	1,892.40	SEG4504511	2,188.00
500	665	501	306	SEG5004517	2,248.20	SEG5004511	2,676.40
560	698	517	334	SEG5604517	2,637.70	SEG5604511	3,211.20
630	741	538	375	SEG6304517	3,126.20	SEG6304511	3,874.30
710	791	582	428	SEG7104517	P.O.A	SEG7104511	P.O.A
800	847	661	455	SEG8004517	P.O.A	SEG8004511	P.O.A

Please note:

De-ration of our range of fabricated polyethylene fittings must be taken into account when designing a pipe system.

SEGMENTED BENDS

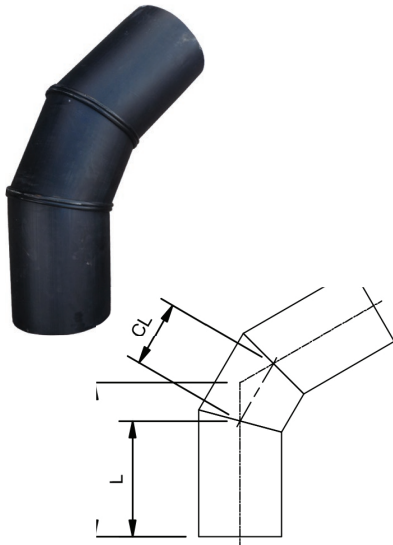

Segmented Bends - 60°

DN	Size			Code	Price	Code	Price
	Z	L	CL	SDR17		SDR11	
250	466	350	201	SEG2506017	634.30	SEG2506011	734.40
280	492	363	225	SEG2806017	1,009.00	SEG2806011	1,123.50
315	576	428	256	SEG3156017	1,126.10	SEG3156011	1,270.00
355	608	443	286	SEG3556017	1,328.10	SEG3556011	1,528.90
400	646	461	322	SEG4006017	1,660.90	SEG4006011	1,934.30
450	689	481	362	SEG4506017	2,062.40	SEG4506011	2,442.30
500	783	551	402	SEG5006017	2,435.10	SEG5006011	2,952.30
560	835	575	450	SEG5606017	2,947.70	SEG5606011	3,557.10
630	896	603	506	SEG6306017	3,467.70	SEG6306011	4,532.70
710	965	635	570	SEG7106017	P.O.A	SEG7106011	P.O.A
800	1043	671	643	SEG8006017	P.O.A	SEG8006011	P.O.A

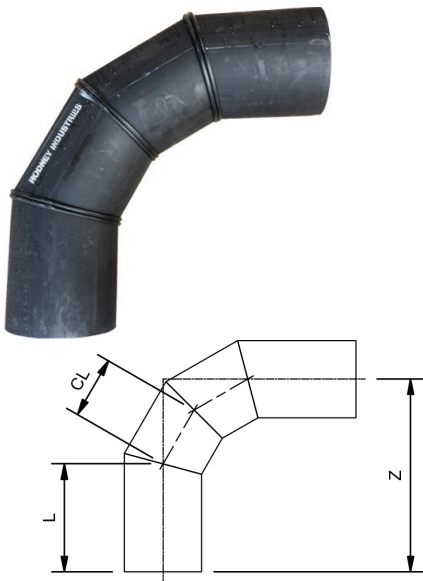

Segmented Bends - 90°

DN	Size			Code	Price	Code	Price
	Z	L	CL	SDR17		SDR11	
250	625	350	201	SEG2509017	1,180.30	SEG2509011	1,278.40
280	670	363	225	SEG2809017	1,324.10	SEG2809011	1,458.80
315	778	428	256	SEG3159017	1,477.10	SEG3159011	1,657.00
355	833	443	286	SEG3559017	1,791.70	SEG3559011	2,036.90
400	900	461	322	SEG4009017	2,186.60	SEG4009011	2,537.80
450	975	481	362	SEG4509017	2,612.40	SEG4509011	3,079.20
500	1100	551	402	SEG5009017	3,203.50	SEG5009011	4,058.80
560	1190	575	450	SEG5609017	3,887.40	SEG5609011	5,034.90
630	1295	603	506	SEG6309017	P.O.A	SEG6309011	5,726.10
710	1414	635	570	SEG7109017	P.O.A	SEG7109011	P.O.A
800	1550	671	643	SEG8009017	P.O.A	SEG8009011	P.O.A

Please note: De-ration of our range of fabricated polyethylene fittings must be taken into account when designing a pipe system.

SWEEP BENDS

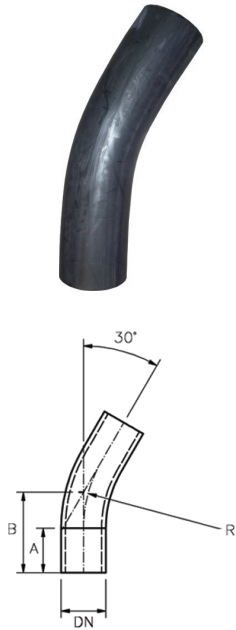

Sweep Bends - 30°

DN	Size			Code	Price	Code	Price
	B	A	R	SDR17		SDR11	
63	114	63	189	SW0633017	86.30	SW0633011	87.70
75	135	75	225	SW0753017	91.80	SW0753011	93.20
90	162	90	270	SW0903017	93.20	SW0903011	98.00
110	198	110	330	SW1103017	130.80	SW1103011	134.20
125	225	125	375	SW1253017	167.80	SW1253011	176.10
140	266	140	470	SW1403017	208.90	SW1403011	219.30
160	289	160	480	SW1603017	250.90	SW1603011	267.30
180	338	180	590	SW1803017	298.00	SW1803011	322.10
200	361	200	600	SW2003017	344.70	SW2003011	376.90
225	406	225	675	SW2253017	386.40	SW2253011	446.00
250	451	250	750	SW2503017	470.00	SW2503011	531.70
280	505	280	840	SW2803017	551.50	SW2803011	635.10
315	568	315	945	SW3153017	694.80	SW3153011	832.40
355	640	355	1065	SW3553017	829.70	SW3553011	1,018.00

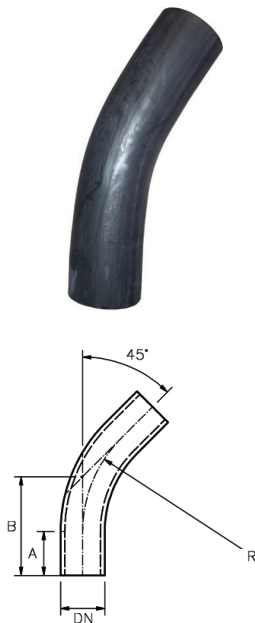

Sweep Bends - 45°

DN	Size			Code	Price	Code	Price
	B	A	R	SDR17		SDR11	
63	141	63	189	SW0634517	87.70	SW0634511	89.10
75	168	75	225	SW0754517	93.20	SW0754511	94.60
90	202	90	270	SW0904517	94.60	SW0904511	99.30
110	247	110	330	SW1104517	132.20	SW1104511	138.40
125	280	125	375	SW1254517	172.70	SW1254511	183.60
140	335	140	470	SW1404517	213.10	SW1404511	226.90
160	359	160	480	SW1604517	258.20	SW1604511	276.10
180	424	180	590	SW1804517	309.00	SW1804511	337.10
200	449	200	600	SW2004517	358.40	SW2004511	395.20
225	505	225	675	SW2254517	398.00	SW2254511	468.60
250	561	250	750	SW2504517	493.90	SW2504511	565.90
280	628	280	840	SW2804517	583.00	SW2804511	683.00
315	706	315	945	SW3154517	694.80	SW3154511	832.40
355	796	355	1065	SW3554517	839.80	SW3554511	1,034.50

Please note: The above dimensions are provided as a guide only. Accuracy of the above data is not guaranteed and dimensions may change without notice.



Hard Back Sweep Bends available upon request. Contact our Sales Department for more information and pricing.

SWEEP BENDS

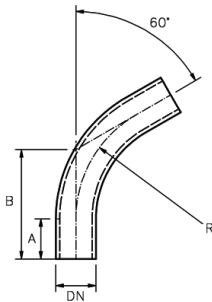

Sweep Bends - 60°

DN	Size			Code	Price	Code	Price
	B	A	R	SDR17		SDR11	
63	172	63	189	SW0636017	87.70	SW0636011	89.10
75	205	75	225	SW0756017	93.20	SW0756011	94.60
90	246	90	270	SW0906017	94.60	SW0906011	101.40
110	301	110	330	SW1106017	135.70	SW1106011	141.20
125	342	125	375	SW1256017	176.10	SW1256011	186.30
140	411	140	470	SW1406017	217.20	SW1406011	234.40
160	437	160	480	SW1606017	263.80	SW1606011	286.40
180	521	180	590	SW1806017	319.40	SW1806011	354.20
200	546	200	600	SW2006017	369.90	SW2006011	415.30
225	615	225	675	SW2256017	415.30	SW2256011	497.40
250	683	250	750	SW2506017	519.20	SW2506011	603.60
280	765	280	840	SW2806017	626.30	SW2806011	746.90
315	861	315	945	SW3156017	853.60	SW3156011	1,067.50
355	970	355	1065	SW3556017	917.40	SW3556011	1,149.70

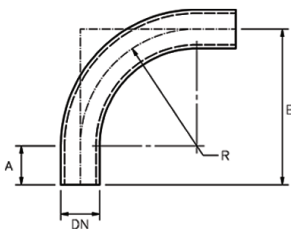

Sweep Bends - 90°

DN	Size			Code	Price	Code	Price
	B	A	R	SDR17		SDR11	
63	252	63	189	SW0639017	87.70	SW0639011	90.40
75	300	75	225	SW0759017	94.60	SW0759011	98.00
90	360	90	270	SW0909017	99.30	SW0909011	105.60
110	440	110	330	SW1109017	138.40	SW1109011	147.30
125	500	125	375	SW1259017	181.50	SW1259011	198.00
140	610	140	470	SW1409017	229.50	SW1409011	250.90
160	640	160	480	SW1609017	279.50	SW1609011	307.60
180	770	180	590	SW1809017	341.90	SW1809011	386.40
200	800	200	600	SW2009017	396.70	SW2009011	454.30
225	900	225	675	SW2259017	446.00	SW2259011	555.70
250	1000	250	750	SW2509017	575.50	SW2509011	685.80
280	1120	280	840	SW2809017	696.10	SW2809011	852.30
315	1260	315	945	SW3159017	853.60	SW3159011	1,067.50
355	1420	355	1065	SW3559017	1,061.20	SW3559011	1,366.20

Please note:

The above dimensions are provided as a guide only. Accuracy of the above data is not guaranteed and dimensions may change without notice.

STUB FLANGES

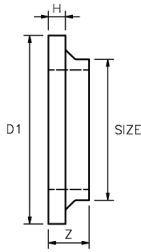

Stub Flange - Short Spigot

mm	Size			Code	Price	Code	Price
	D1	Z	H	SDR17		SDR11	
63	96	50	14	SF06317	9.10	SF06311	9.10
75	108	50	14	SF07517	10.30	SF07511	10.30
90	128	60	14	SF09017	12.60	SF09011	10.30
110	160	60	14	SF11017	16.10	SF11011	16.10
125	192	65	25	SF12517	19.40	SF12511	19.40
140	192	65	25	SF14017	29.70	SF14011	43.50
160	217	65	25	SF16017	28.70	SF16011	26.40
180	274	75	25	SF18017	43.50	SF18011	43.50
200	274	75	25	SF20017	48.10	SF20011	56.10
225	274	75	25	SF22517	52.60	SF22511	65.20
250	334	80	30	SF25017	77.80	SF25011	75.50
280	334	80	30	SF28017	84.70	SF28011	84.70
315	380	80	30	SF31517	100.70	SF31511	117.90
355	444	90	40	SF35517	128.20	SF35511	157.90
400	495	90	40	SF40017	163.70	SF40011	223.20
450	545	90	40	SF45017	212.80	SF45011	376.50
500	602	105	50	SF50017	277.00	SF50011	392.60
560	657	105	55	SF56017	392.60	SF56011	422.30
630	714	105	55	SF63017	432.60	SF63011	505.90

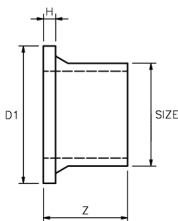

Stub Flange - Long Spigot

mm	Size			Code	Price	Code	Price
	D1	Z	H	SDR17		SDR11	
63	96	91	14	SF06317EF	9.10	SF06311EF	9.10
75	108	96	14	SF07517EF	10.30	SF07511EF	10.30
90	128	106	14	SF09017EF	12.60	SF09011EF	12.60
110	160	116	14	SF11017EF	17.20	SF11011EF	17.20
125	192	126	25	SF12517EF	20.60	SF12511EF	22.90
140	192	132	25	SF14017EF	29.70	SF14011EF	32.00
160	217	142	25	SF16017EF	32.00	SF16011EF	35.50
180	274	157	25	SF18017EF	48.10	SF18011EF	48.10
200	274	157	25	SF20017EF	59.50	SF20011EF	65.20
225	274	200	25	SF22517EF	66.40	SF22511EF	66.40
250	334	205	30	SF25017EF	97.30	SF25011EF	112.10
280	334	280	30	SF28017EF	172.70	SF28011EF	131.70
315	444	280	30	SF31517EF	163.70	SF31511EF	174.00
355	495	290	40	SF35517EF	267.90	SF35511EF	471.50
400	545	290	40	SF40017EF	369.70	SF40011EF	808.40

MAXI STUBS

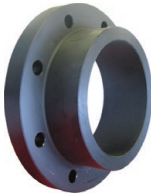

Note: Standard Maxi Stub - SDR 11 PE100 drilled to suit Table D backing ring. Other sizes available upon application.

Maxi Stub Short Spigot

Pipe Ø	Size		OD	Code	Price
	inches	mm			
125	4	100	215	MX412511D	42.10
160	5	125	225	MX516011D	70.20
180	6	150	280	MX618011D	76.90
200	6	150	280	MX620011D	151.40
225	8	200	335	MX822511D	171.30
250	8	200	335	MX825011D	184.50
280	9	225	370	MX928011D	218.20
280	10	250	405	MX1028011D	224.10
315	10	250	405	MX1031511D	230.20
355	12	300	455	MX1235511D	295.60

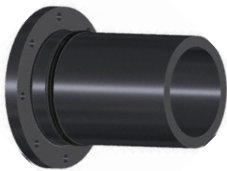

Maxi Stub Long Spigot Suitable for Electrofusion or Buttwelding

Pipe Ø	Size		OD	Code	Price
	inches	mm			
125	4	100	215	MX412511DEF	119.10
180	6	150	280	MX618011DEF	108.80
250	8	200	335	MX825011DEF	338.20
315	10	250	405	MX1031511DEF	301.60
355	12	300	455	MX1235511DEF	442.90



Backing Ring to Suit Maxi Stub

Backing Ring mm	Size		Pipe mm	Code	Price
	To Suit Maxi inches				
100	4	125	BRX4140D	42.10	
125	5	160	BRX5160D	55.90	
150	6	200	BRX6200D	70.20	
200	8	250	BRX8250D	102.80	
225	9	280	BRX9280D	325.10	
250	10	315	BRX10315D	119.10	
300	12	355	BRX12355D	158.00	

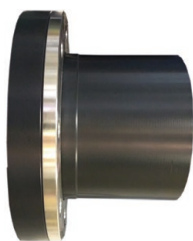

Maxi Stub Assembly complete with Stainless Steel 316 Backing Ring

Pipe Ø	Size		OD	Code	Price
	inches	mm			
125	4	100	215	MX412511EFASSY	147.60
180	6	150	280	MX618011EFASSY	217.50
200	6	150	280	MX620011EFASSY	464.10
225	8	200	335	MX822511EFASSY	650.70
250	8	200	335	MX825011EFASSY	457.70
280	9	225	370	MX928011EFASSY	723.20
315	10	250	405	MX1031511EFASSY	686.10
355	12	300	455	MX1235511EFASSY	847.20

POLYETHYLENE FITTINGS

VALVE SPACERS AND SHOULDERED ENDS



Stub Flange - Chamfered for Butterfly Valve SDR11

Size	Code	Price
110	SF11011EFBV	36.60
160	SF16011EFBV	54.00
200	SF20011EFBV	94.90
225	SF22511EFBV	94.90
250	SF25011EFBV	132.70
280	SF28011EFBV	159.20
315	SF31511EFBV	252.90



Valve Spacer - Wafer Style

Pipe OD	Spacer OD	Size				Code	Price
		ID-1	ID-2	THK	Angle		
110	160	89	99	14	20	VSW11011	7.20
125	192	102	125	25	25	VSW12511	16.80
140	192	114	132	25	20	VSW14011	39.60
160	213	130	153	25	25	VSW16011	16.80
200	270	163	209	40	30	VSW20011	39.60
225	270	183	206	25	25	VSW22511	24.00
250	334	203	259	60	25	VSW25011	88.90
280	334	228	263	30	30	VSW28011	50.50
315	380	256	325	60	30	VSW31511	113.00
355	444	289	358	60	30	VSW35511	147.80
400	495	325	418	100	25	VSW40011	213.90
450	545	366	459	100	25	VSW45011	336.50
500	602	407	500	100	25	VSW50011	396.60



Shouldered Ends

Size	Code	Price	Code		Price
			SDR17	SDR11	
90	SE09017	19.40	SE09011	19.40	
90	SE09017EF	19.40	SE09011EF	19.40	
110	SE11017	20.60	SE11011	20.60	
110	SE11017EF	22.90	SE11011EF	22.90	
160	SE16017	32.00	SE16011	32.00	
160	SE16017EF	39.00	SE16011EF	39.00	
200	SE20017	75.50	SE20011	75.50	
225	SE22517	81.30	SE22511	81.30	

Note: EF Codes represent Long Spigot Shouldered Ends

NUTS, BOLTS AND GASKET KITS



Nuts, Bolts and Gasket Kits

Gasket Size mm	Nut & Bolt Qty	Washer Qty	Code	Price
63	4	8	GK063D	50.50
75	4	8	GK075D	50.50
90	4	8	GK090D	55.90
110	4	8	GK110D	60.70
125	8	16	GK125D	75.80
140	8	16	GK140D	75.80
160	8	16	GK160D	75.80
180	8	16	GK180D	87.00
200	8	16	GK200D	87.00
225	8	16	GK225D	87.00
250	8	16	GK250D	109.30
280	12	24	GK280D	109.30
315	12	24	GK315D	144.80
355	12	24	GK355D	218.20
400	12	24	GK400D	221.10
450	12	24	GK450D	221.10
500	16	32	GK500D	298.60
560	16	32	GK560D	P.O.A
630	16	32	GK630D	P.O.A
710	16	32	GK710D	P.O.A

MOULDED BENDS AND TEES

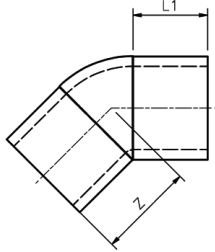

Elbows 45° Moulded - BW & EF

mm	Size		Code		Price	Code		Price
	L1	Z	SDR17			SDR11		
75	80	124	ELB0754517EF		13.80	ELB0754511EF		13.80
90	85	136	ELB0904517EF		17.20	ELB0904511EF		17.20
110	87	145	ELB1104517EF		26.40	ELB1104511EF		26.40
125	87	150	ELB1254517EF		32.00	ELB1254511EF		32.00
160	98	175	ELB1604517EF		54.90	ELB1604511EF		54.90
180	105	183	ELB1804517EF		68.70	ELB1804511EF		68.70
200	110	193	ELB2004517EF		84.70	ELB2004511EF		86.90
225	125	215	ELB2254517EF		137.30	ELB2254511EF		147.60
250	130	232	ELB2504517EF		167.10	ELB2504511EF		200.30
280	140	250	ELB2804517EF		215.10	ELB2804511EF		241.50
315	150	270	ELB3154517EF		494.40	ELB3154511EF		566.60

Elbows 90° Moulded - BW & EF

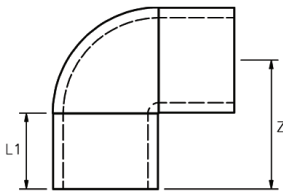

mm	Size		Code		Price	Code		Price
	L1	Z	SDR17			SDR11		
75	75	132	ELB0759017EF		13.80	ELB0759011EF		13.80
90	85	150	ELB0909017EF		17.20	ELB0909011EF		17.20
110	89	163	ELB1109017EF		26.40	ELB1109011EF		26.40
125	90	170	ELB1259017EF		32.00	ELB1259011EF		32.00
160	103	200	ELB1609017EF		54.90	ELB1609011EF		54.90
180	96	210	ELB1809017EF		68.70	ELB1809011EF		68.70
200	104	225	ELB2009017EF		89.30	ELB2009011EF		91.60
225	125	265	ELB2259017EF		137.30	ELB2259011EF		153.40
250	130	290	ELB2509017EF		196.90	ELB2509011EF		208.30
280	140	315	ELB2809017EF		251.80	ELB2809011EF		277.00
315	150	355	ELB3159017EF		382.30	ELB3159011EF		455.50

Tees Moulded - Long Spigot

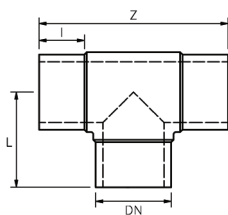

DN	Size			Code		Price	Code		Price
	Z	L	I	SDR17			SDR11		
63	110	220	63	TM06317EF		17.20	TM06311EF		16.10
75	132	264	75	TM07517EF		22.90	TM07511EF		17.20
90	150	300	85	TM09017EF		32.00	TM09011EF		25.20
110	163	326	87	TM11017EF		45.80	TM11011EF		45.80
125	170	341	87	TM12517EF		56.10	TM12511EF		56.10
140	190	380	98	TM14017EF		123.60	TM14011EF		143.10
160	210	400	96	TM16017EF		95.00	TM16011EF		95.00
180	205	410	96	TM18017EF		112.10	TM18011EF		112.10
200	225	450	100	TM20017EF		157.90	TM20011EF		167.10
225	265	530	12	TM22517EF		246.10	TM22511EF		279.30
250	300	600	130	TM25017EF		307.90	TM25011EF		394.90
280	315	632	138	TM28017EF		394.90	TM28011EF		451.00
315	355	710	150	TM31517EF		497.90	TM31511EF		718.70
355*	330	660	110	TM35517EF		1,105.50	TM35511EF		1,475.30

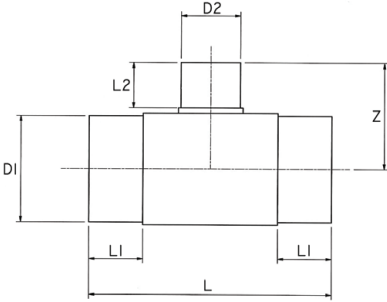

Tees Moulded - Reducing Long Spigot

Size						Code	Price	Code	Price
D1	D2	L	L1	L2	Z	SDR17		SDR11	
110	63	300	85	85	161	TMR1106317EF	49.20	TMR1106311EF	51.60
110	75	300	87	85	162	TMR1107517EF	51.60	TMR1107511EF	52.60
110	90	300	89	85	162	TMR1109017EF	51.60	TMR1109011EF	52.60
160	63	330	91	90	191	TMR1606317EF	116.80	TMR1606311EF	121.30
160	75	330	92	90	191	TMR1607517EF	120.20	TMR1607511EF	123.60
160	90	330	92	90	189	TMR1609017EF	121.30	TMR1609011EF	127.10
160	110	330	91	90	188	TMR16011017EF	124.70	TMR16011011EF	128.20
200	110	450	100	85	200	TMR20011017EF	260.90	TMR20011011EF	271.20
200	160	450	100	100	450	TMR20016017EF	265.50	TMR20016011EF	277.00
250	110	600	130	80	405	TMR25011017EF	398.30	TMR25011011EF	441.70
250	160	600	130	100	475	TMR25016017EF	451.00	TMR25016011EF	451.00

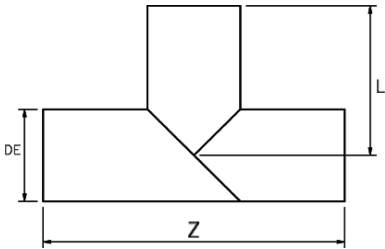

Tees - Fabricated

Size			Code	Price	Code	Price
DE	Z	L	SDR17		SDR11	
315	760	380	TF31517	1,013.30	TF31511	1,129.20
355	800	400	TF35517	1,122.80	TF35511	1,340.20
400	960	480	TF40017	1,404.80	TF40011	1,746.30
450	1010	505	TF45017	1,660.70	TF45011	2,157.60
500	1060	530	TF50017	1,922.60	TF50011	2,517.40
560	1190	595	TF56017	2,309.00	TF56011	2,859.00
630	1190	595	TF63017	3,557.90	TF63011	4,649.70

JUNCTIONS AND END CAPS

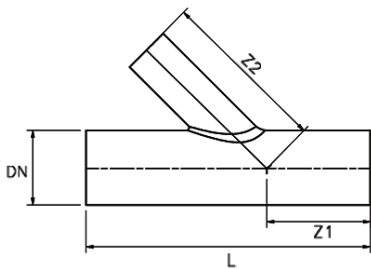

Junctions - 45° Equal Fabricated Long Spigot

DN	Size			Code	Price	Code	Price
	L	Z1	Z2	SDR17		SDR11	
110	700	275	425	J1104517	108.50	J1104511	108.50
125	745	290	455	J1254517	126.90	J1254511	142.70
160	840	330	510	J1604517	201.90	J1604511	291.30
200	960	370	590	J2004517	376.90	J2004511	478.80
225	1080	425	655	J2254517	520.30	J2254511	520.30
250	1155	450	705	J2504517	751.80	J2504511	751.80
280	1245	490	755	J2804517	966.10	J2804511	966.10
315	1340	525	815	J3154517	1,215.40	J3154511	1,215.40
355	1455	575	880	J3554517	1,786.90	J3554511	1,786.90
400	1550	600	950	J4004517	1,877.70	J4004511	2,272.40
450	1625	625	1000	J4504517	2,219.10	J4504511	2,751.80
500	1700	650	1050	J5004517	2,611.70	J5004511	3,299.00
560	1904	728	1176	J5604517	3,529.20	J5604511	4,498.60
630	2147	819	1323	J6304517	4,621.00	J6304511	5,999.50



End Caps Domed - Long Spigot

Size	Code	Price	Code	Price
	SDR17		SDR11	
63	ECD06317	12.60	ECD06311	12.60
75	ECD07517	12.60	ECD07511	12.60
90	ECD09017	14.90	ECD09011	14.90
110	ECD11017	18.30	ECD11011	20.60
125	ECD12517	24.00	ECD12511	26.40
140	ECD14017	54.90	ECD14011	54.90
160	ECD16017	56.10	ECD16011	56.10
180	ECD18017	57.20	ECD18011	57.20
200	ECD20017	60.70	ECD20011	68.70
225	ECD22517	63.00	ECD22511	85.90
250	ECD25017	65.20	ECD25011	101.90
280	ECD28017	72.10	ECD28011	133.90
315	ECD31517	91.60	ECD31511	169.40
355	ECD35517	103.00	ECD35511	360.60
400	ECD40017	151.10	ECD40011	512.70

REDUCERS

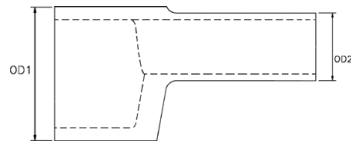

Reducers Eccentric - Long Spigot

Size		Code	Price	Code	Price
OD1	OD2	SDR17		SDR 11	
90	63	RE09006317EF	29.70	RE09006311EF	32.00
90	75	RE09007517EF	29.70	RE09007511EF	32.00
110	63	RE11006317EF	40.10	RE11006311EF	43.50
110	90	RE11009017EF	40.10	RE11009011EF	43.50
125	63	RE12506317EF	48.10	RE12506311EF	52.60
125	90	RE12509017EF	48.10	RE12509011EF	52.60
125	110	RE12511017EF	48.10	RE12511011EF	113.30
140	125	RE14012517EF	68.70	RE14012511EF	75.50
160	90	RE16009017EF	93.90	RE16009011EF	100.70
160	110	RE16011017EF	93.90	RE16011011EF	100.70
160	125	RE16012517EF	93.90	RE16012511EF	100.70
160	140	RE16014017EF	93.90	RE16014011EF	100.70
180	90	RE18009017EF	120.20	RE18009011EF	130.50
180	125	RE18012517EF	120.20	RE18012511EF	130.50
180	160	RE18016017EF	120.20	RE18016011EF	130.50
200	160	RE20016017EF	131.70	RE20016011EF	143.10
200	180	RE20018017EF	131.70	RE20018011EF	143.10
225	160	RE22516017EF	211.80	RE22516011EF	228.90
225	180	RE22518017EF	211.80	RE22518011EF	228.90
225	200	RE22520017EF	211.80	RE22520011EF	228.90
250	200	RE25020017EF	278.10	RE25020011EF	301.00
250	225	RE25022517EF	278.10	RE25022511EF	301.00

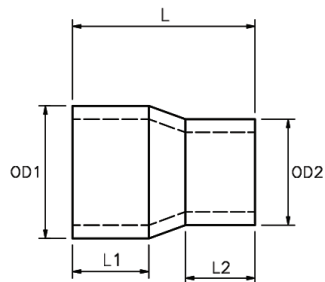

Reducers Concentric - Long Spigot

Size					Code	Price	Code	Price
OD1	OD2	L	I1	I2	SDR 17		SDR 11	
75	63	127	61	57	RC07506317EF	12.60	RC07506311EF	12.60
90	63	190	85	75	RC09006317EF	17.20	RC09006311EF	17.20
90	75	145	71	61	RC09007517EF	17.20	RC09007511EF	17.20
110	90	166	83	71	RC11009017EF	22.90	RC11009011EF	22.90
125	63	210	85	85	RC12506317EF	28.70	RC12506311EF	28.70
125	90	182	87	71	RC12509017EF	22.90	RC12509011EF	22.90
125	110	210	105	105	RC12511017EF	25.20	RC12511011EF	25.20
140	125	210	105	105	RC14012517EF	39.00	RC14012511EF	42.30
160	90	320	105	105	RC16009017EF	52.60	RC16009011EF	52.60
160	110	320	115	105	RC16011017EF	45.80	RC16011011EF	48.10
160	125	320	115	105	RC16012517EF	45.80	RC16012511EF	48.10
200	160	360	120	105	RC20016017EF	77.80	RC20016011EF	79.00

REDUCERS

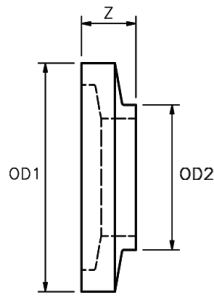

Reducers Concentric - Short Spigot

Size		Code	Price	Code	Price
OD1	OD2	SDR17		SDR11	
180	125	RC18012517	52.60	RC18012511	54.90
180	160	RC18016017	66.40	RC18016011	66.40
200	110	RC20011017	45.80	RC20011011	45.80
200	140	RC20014017	137.30	RC20014011	143.10
200	160	RC20016017	77.80	RC20016011	79.00
200	180	RC20018017	49.20	RC20018011	81.30
225	140	RC22514017	166.00	RC22514011	174.00
225	160	RC22516017	116.80	RC22516011	130.50
225	180	RC22518017	123.60	RC22518011	130.50
225	200	RC22520017	68.70	RC22520011	68.70
250	160	RC25016017	72.10	RC25016011	72.10
250	200	RC25020017	74.40	RC25020011	74.40
250	225	RC25022517	72.10	RC25022511	72.10
280	200	RC28020017	211.80	RC28020011	219.80
280	225	RC28022517	196.90	RC28022511	199.20
280	250	RC28025017	192.30	RC28025011	200.30
315	200	RC31520017	311.30	RC31520011	327.30
315	225	RC31522517	277.00	RC31522511	251.80
315	250	RC31525017	180.80	RC31525011	322.80
315	280	RC31528017	203.70	RC31528011	267.90
355	200	RC35520017	160.20	RC35520011	P.O.A
355	250	RC35525017	160.20	RC35525011	322.80
355	280	RC35528017	149.90	RC35528011	249.50
355	315	RC35531517	153.40	RC35531511	349.10
400	200	RC40020017	174.00	RC40020011	P.O.A
400	250	RC40025017	174.00	RC40025011	P.O.A
400	280	RC40028017	P.O.A	RC40028011	P.O.A
400	315	RC40031517	163.70	RC40031511	339.90
400	355	RC40035517	223.20	RC40035511	350.20
450	200	RC45020017	211.80	RC45020011	P.O.A
450	250	RC45025017	218.60	RC45025011	P.O.A
450	315	RC45031517	218.60	RC45031511	890.40
450	355	RC45035517	708.80	RC45035511	P.O.A
450	400	RC45040017	737.10	RC45040011	890.40
500	315	RC50031517	369.70	RC50031511	808.00
500	355	RC50035517	369.70	RC50035511	1,158.30
500	400	RC50040017	383.50	RC50040011	509.40
500	450	RC50045017	425.80	RC50045011	470.40
560	400	RC56040017	425.80	RC56040011	600.90
560	450	RC56045017	425.80	RC56045011	716.40
630	400	RC63040017	552.80	RC63040011	P.O.A
630	450	RC63045017	509.40	RC63045011	1,264.70

BACKING RINGS



Backing Rings - Table D Galvanised Steel

Poly pipe OD	Size		Code	Price
	Flange Size	THK		
63	50	10	BR063D2	11.40
75	65	10	BR075D2	12.60
90	80	10	BR090DE	P.O.A
110	100	10	BR110D2	24.00
125	125	13	BR125D2	35.50
140	125	13	BR140D2	30.90
160	150	13	BR160D2	35.50
180	150	13	BR180D2	30.90
200	200	13	BR200D2	44.60
225	200 (8")	13	BR225D2	43.50
250	250	16	BR250D2	83.60
280	250	16	BR280D2	81.30
315	300	19	BR315D2	114.50
355	350	22	BR355DE	P.O.A
400	400	22	BR400D2	179.70
450	450	25	BR450D2	257.60
500	500	29	BR500D2	333.10
560	550	32	BR560D2	298.70
630	600	32	BR630D2	455.50
710	700	35	BR710D2	532.20
800	800	38	BR800D2	933.90
1000	1000	51	BR1000D2	1,355.10

Backing Rings - Table E Galvanised Steel

Poly pipe OD	Size		Code	Price
	Flange Size	THK		
63	50	10	BR063E2	11.40
75	65	10	BR075E2	12.60
90	80	12	BR090DE	P.O.A
110	100	13	BR110E2	24.00
125	125	13	BR125E2	36.60
140	125	14	BR140E2	32.00
160	150	17	BR160E2	43.50
180	150	17	BR180E2	40.10
200	200	19	BR200E2	58.40
225	200 (8")	19	BR225E2	56.10
250	250	22	BR250E2	95.00
280	250	22	BR280E2	90.40
315	300	25	BR315E2	121.30
355	350	29	BR355E2	215.10
400	400	32	BR400E2	260.90
450	450	35	BR450E2	354.80
500	500	38	BR500E2	437.20
560	550	44	BR560E2	537.90
630	600	48	BR630E2	674.10
710	700	51	BR710E2	750.80
800	800	54	BR800E2	1,223.50
900	900	64	BR900E2	1,695.00
1000	1000	67	BR1000E2	1,738.50

BACKING RINGS



Backing Rings - ANSI Galvanised Steel

Poly pipe OD	Size		Code	Price
	Flange Size	THK		
63	50	10	BR063A	-
75	65	10	BR075A	29.70
90	80	11	BR090A	-
110	100	13	BR110A	48.10
125	125	14	BR125A	59.50
140	125	14	BR140A	76.70
160	150	17	BR160A	96.20
180	150	17	BR180A	-
200	200	19	BR200A	-
225	200 (8")	19	BR225A	P.O.A
250	250	22	BR250A	131.70
280	250	22	BR280A	121.30
315	300	25	BR315A	201.40
355	350	29	BR355A	277.00
400	400	32	BR400A	353.60
450	450	32	BR450A	369.70
500	500	43	BR500A	420.00
560	550	48	BR560A	543.70
630	600	50	BR630A	582.50
710	700	50	BR710A	P.O.A
800	800	60	BR800A	P.O.A

Blank Flange - Galvanised Steel

Poly pipe OD	Size Flange	Code Table D	Price	Code Table E	Price
63	2"	BF063DE	23.40	BF063DE	23.40
75	2.5"	BF075DE	23.40	BF075DE	23.40
90	3"	BF090E	24.60	BF090E	24.60
110	4"	BF110D	38.40	BF110E	38.40
125	5"	BF125D	59.50	BF125E	59.50
160	6"	BF160D	86.00	BF160E	86.00
200	8"	BF225D	113.50	BF225E	131.70
250	10"	BF280D	164.50	BF280E	220.00
315	12"	BF315D	256.60	BF315E	334.10
355	14"	BF355D	394.20	BF355E	647.10
400	16"	BF400D	483.60	BF400E	694.60
450	18"	BF450D	P.O.A	BF450E	P.O.A
500	20"	BF500D	P.O.A	BF500E	P.O.A
630	24"	BF630D	P.O.A	BF630E	P.O.A
710	28"	BF710D	P.O.A	BF710E	P.O.A
800	32"	BF800D	P.O.A	BF800E	P.O.A
1000	40"	BF1000D	P.O.A	BF1000E	P.O.A

BACKING RINGS



Backing Rings - Table D 316 Stainless Steel

Size		Code	Price
Poly Pipe OD	Flange Size		
63	2"	BRS063D	40.10
75	2 ½"	BRS075D	45.80
90	3"	BRS090E	54.90
110	4"	BRS110D	86.90
125	5"	BRS125D	130.50
140	5"	BRS140D	114.50
160	6"	BRS160D	135.00
180	6"	BRS180D	115.60
200	8"	BRS200D	166.00
225	8"	BRS225D	161.40
250	10"	BRS250D	343.40
280	10"	BRS280D	331.90
315	12"	BRS315D	468.10
355	14"	BRS355D	650.10
400	15"	BRS400D	738.30
450	16"	BRS450D	1,056.40
500	18"	BRS500D	1,372.20
560	20"	BRS560D	1,230.40
630	24"	BRS630D	1,873.50
710	28"	BRS710D	2,150.50
800	32"	BRS800D	3,924.50
1000	40"	BRS1000D	5,568.00

Backing Rings - Table E 316 Stainless Steel

Size		Code	Price
Poly Pipe OD	Flange Size		
63	2"	BRS063E	45.80
75	2 ½"	BRS075E	45.80
90	3"	BRS090E	54.90
110	4"	BRS110E	86.90
125	5"	BRS125E	140.80
140	5"	BRS140E	123.60
160	6"	BRS160E	170.50
180	6"	BRS180E	156.80
200	8"	BRS200E	236.90
225	8"	BRS225E	230.10
250	10"	BRS250E	388.00
280	10"	BRS280E	369.70
315	12"	BRS315E	495.60
355	14"	BRS355E	885.90
400	15"	BRS400E	1,073.50
450	16"	BRS450E	1,457.00
500	18"	BRS500E	1,796.90
560	20"	BRS560E	2,214.70
630	24"	BRS630E	2,776.50
710	28"	BRS710E	3,087.80
800	32"	BRS800E	5,360.90
1000	40"	BRS1000E	7,225.30



Rodney Industries

A Division of Vinidex Pty Limited

BUILT FOR STRENGTH, BUILT FOR QUALITY, BUILT TO LAST

We pride ourselves in our continued manufacture and supply of quality products and services.

Why choose Rodney Industries' Irrigation Fittings?

We understand the importance of quality and value for money. Take for example our hose joiner:

- Heavier wall thickness for strength and durability.
- Chamfered for easy installation and hose protection.
- Smooth tapered spigot to reduce rusting and cutting inside irrigation hose.
- Hot dipped galvanized for longer lifespan.





IRRIGATION FITTINGS

*For range and quality, choose
Rodney Industries' fittings*

We offer a large selection of Irrigation fittings including:

- Hose Joiners
- Bauer Style Fittings
- Weld Bells
- Mainline Adaptors



IRRIGATION FITTINGS



Plain to Half Joinder

Inch	Code	Price
3" x 3½"	10004	135.00
4" x 3"	10989	136.50
4" x 3½"	9899	149.40
4" x 4"	10012	153.00
4" x 5"	10024	200.50
5" x 3½"	9987	200.50
5" x 4"	9988	203.90
5" x 4½"	9989	247.30
5" x 5"	10999	250.10
5" x 6"	10025	265.20
6" x 4"	10023	220.40
6" x 5"	9900	252.20
6" x 6"	10998	272.80

Threaded to Half Joinder

Inch	Code	Price
2½" x 2½"	9927	135.10
2" x 3"	9929	133.90
2½" x 3"	9930	135.10
3" x 2½"	9926	141.10
3" x 3"	9931	141.10
2½" x 3½"	9932	148.30
3" x 3½"	9933	154.20
2½" x 4"	9934	151.50
3" x 4"	9935	156.80
4" x 3½"	9937	159.50
4" x 4"	9936	164.00
4" x 4½"	9938	207.90
4" x 6"	9939	262.40



Flange to Half Joinder

Inch	Code	Price
2" x 2½"	9944	135.00
2½" x 3"	9946	149.40
3" x 3"	9947	153.00
4" x 2½"	10033	150.90
4" x 3"	9948	155.80
3" x 3½"	9949	164.70
4" x 3½"	9950	177.00
5" x 3½"	9951	188.70
6" x 3½"	9952	197.80
3" x 4"	9953	170.20
4" x 4"	9964	205.40

Flange to Half Joinder

Inch	Code	Price
4" x 5"	9961	208.80
5" x 4"	9954	190.20
6" x 4"	9955	203.90
4" x 4½"	9956	190.20
5" x 4½"	9957	239.70
6" x 4½"	9958	245.90
5" x 5"	10007	215.60
5" x 6"	10008	238.40
6" x 5"	9960	247.30
6" x 6"	9962	252.20

IRRIGATION FITTINGS



Hose Joiner

Inch	Code	Price
2"	9980	68.30
2½"	9981	69.50
3"	9982	71.00
3½"	9983	84.80
4"	9984	92.40
4½"	9985	159.20
5"	10005	173.70
6"	10006	206.70



Hose Joiner Reducing

Inch	Code	Price
2 ½" x 3"	10031	127.40
3" x 3½"	10003	148.20
3" x 4"	9986	150.90
3½" x 4"	9978	168.80
4" x 4½"	9979	174.90



Coupler Joiner

Inch	Code	Price
3" x 3"	9973	327.30
4" x 3"	9974	436.80
4" x 4"	9975	357.60

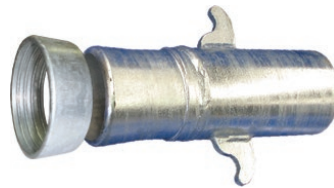

Ring Type Coupler - (Hosetail x Coupler)

Inch	Code	Price
2½" x 3"	9990	149.40
2 ½" x 4"	9996	154.30
3" x 3"	9991	153.00
3 ½" x 3"	10002	187.40
3" x 4"	9992	182.50
3 ½" x 4"	9997	202.40
3 ½" x 5"	10014	242.50
4" x 4"	9998	178.40
4" x 5"	10015	245.90
4 ½" x 4"	9999	239.70
4" x 3"	10000	194.30
4 ½" x 5"	10001	288.10
5" x 4"	10010	265.20
5" x 5"	10018	314.80
6" x 6"	10016	328.60



Standard Coupler (Hosetail x Coupler)

Inch	Code	Price
3" x 4"	10009	408.50
3½" x 4"	9993	356.10
4" x 4"	9994	370.60
4½" x 4"	9995	411.20

IRRIGATION FITTINGS



Flange to Bell

Inch	Code	Price
2½" x 3"	9959	203.90
3" x 3"	9965	206.70
4" x 3"	9969	239.70
3" x 4"	9968	252.20
4" x 4"	9963	259.70
5" x 4"	9967	275.60
5" x 5"	10019	244.60
6" x 4"	9966	288.10
6" x 6"	10017	305.20
6" x 8"	10020	376.20
8" x 8"	10021	337.70

Mainline Adaptor (Bell x Spigot)

Inch	Code	Price
3" x 3"	9970	228.00
3" x 4"	9971	245.90
3" x 5"	10011	256.90
4" x 4"	9972	262.40
4" x 5"	9976	271.50
4" x 6"	10032	277.70
5" x 5"	10022	279.00



Flange to Bell No Lugs \ Links

Inch	Code	Price
3" x 3"	9965HAB	129.00
4" x 4"	9963HA	168.80
5" x 5"	10019HA	220.40
6" x 6"	10017HA	252.20
8" x 8"	10021HA	266.70

Flange to Male Spigot

Inch	Code	Price
3" x 3"	9965MSA	220.40
4" x 4"	9963MSA	225.90
5" x 5"	10019MSA	289.30
6" x 6"	10017MSA	316.20
8" x 8"	10021MSA	467.00

IRRIGATION FITTINGS



Weld Bells c/w Lugs and Links (Black)

Inch	mm	Code	Price
3"	80	9922	131.60
4"	100	9923	116.40
5"	125	9294	153.00
6"	150	9295	179.80
8"	200	9315	187.40



Weld Bells c/w Lugs and Links (Galvanized)

Inch	mm	Code	Price
3"	80	9920	137.80
4"	100	9921	142.00
5"	125	9290	161.90
6"	150	9291	190.20
8"	200	9313	203.90



Weld Bells w/o Lugs and Links (Black)

Inch	mm	Code	Price
3"	80	9297	59.20
4"	100	9298	75.90
5"	125	9299	89.60
6"	150	9300	110.90
8"	200	9317	153.70



Thread to Weld Bells c/w Lugs and Links (Galvanized)

Inch	mm	Code	Price
4" x 4"	100 x 100	10026	313.40
5" x 5"	125 x 125	10027	330.70
4" x 5"	100 x 125	10028	323.80

**Note: All Weld Bells supplied with round-back gaskets*

IRRIGATION FITTINGS



Weld Bell Clamps (Travis Clamps)

Inch	mm	Code	Price
4"	100	9304	36.50
5"	125	9305	67.60
6"	150	9306	82.60
8"	200	9321	89.60



Round Back Gaskets

Inch	mm	Code	Price
3"	80	9924	7.00
4"	100	9925	9.70
5"	125	9310	14.40
6"	150	9312	18.60
8"	200	9319	21.40



Joiner Ring Only

Inch	Code	Price
2"	9901	19.90
2½"	9902	19.90
3"	9903	21.40
3½"	9904	22.80
4"	9905	24.10
4½"	9906	26.90
5"	9908	28.30

IRRIGATION FITTINGS

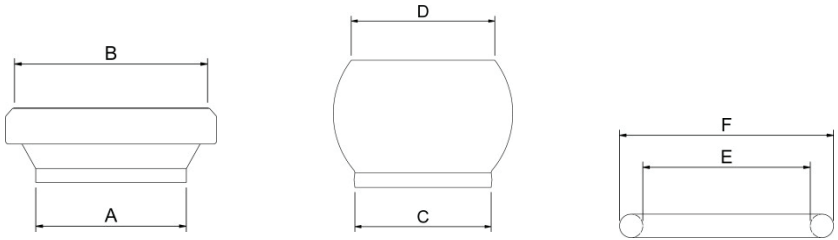

Size		Female Coupling		Male Coupling		Rubber Seal	
inches	mm	A	B	C	D	E	F
2	50	48.5	72	50	48.5	62	80.6
3	76	76	98	81	76	88.5	114.5
3.5	89	89	121	93	89	108	134
4	108	108	147	112	108	132	162
5	133	132	163	137	132	152	188
6	159	158	182	155	158	170	208
8	194	194	231	200	194	220	258



Black Steel Coupling Complete With Rubber Seal

Inch	mm	Code	Price
2	50	12000	43.80
3	76	12002	59.30
3.5	89	12004	85.40
4	108	12006	101.00
5	133	12008	142.60
6	159	12010	172.90

Black Steel Male Coupling

Inch	mm	Code	Price
2	50	12014	10.00
3	76	12016	10.00
3.5	89	12018	16.30
4	108	12020	20.40
5	133	12022	23.30
6	159	12024	33.30
8	194	12026	59.30

IRRIGATION FITTINGS



Galvanized Steel Lever Ring

Inch	mm	Code	Price
2	50	12028	33.30
3	76	12030	48.00
3.5	89	12032	65.70
4	108	12034	81.20
5	133	12036	127.10
6	159	12038	163.20
8	194	12040	253.50



Black Steel Female Coupling With Rubber Seal

Inch	mm	Code	Price
2	50	12042	16.30
3	76	12044	16.30
3.5	89	12046	23.30
4	108	12048	30.40
5	133	12050	42.40
6	159	12052	56.40
8	194	12054	69.90



Rubber O'Ring Seal

Inch	mm	Code	Price
2	50	12056	5.60
3	76	12058	5.60
3.5	89	12060	8.50
4	108	12062	10.00
5	133	12064	13.40
6	159	12066	16.30
8	194	12068	19.10



Galvanized Steel Male End Plug With Lever Ring

Inch	mm	Code	Price
2	50	12084	72.80
3	76	12086	119.20
3.5	89	12088	142.60
4	108	12090	145.50
5	133	12092	214.00
6	159	12094	359.30
8	194	12096	443.40



Galvanized Steel Female Coupling With Hose Tail & Rubber Seal - (Bauer X Tail)

Inch	mm	Code	Price
2	50 x 50	12098	39.50
3	76 x 76	12102	45.20
3.5	89 x 76	12104	59.30
4	108 x 100	12108	77.70
5	133 x 125	12112	107.30
6	159 x 150	12114	130.60
8	194 x 200	12118	247.20



Galvanized Steel Male Coupling With Hose Tail & Lever Ring - (Bauer X Tail)

Inch	mm	Code	Price
2	50 x 50	12120	59.30
3	76 x 76	12124	108.80
3.5	89 x 89	12128	118.00
4	108 x 100	12130	145.50
5	133 x 125	12134	218.10
6	159 x 150	12136	276.80
8	194 x 200	12140	440.60

IRRIGATION FITTINGS



Galvanized Steel Female Coupling Threaded BSPM With Rubber Seal – (Bauer X BSPM)

mm x Inch	Code	Price
50 mm x 2"	12144	90.30
76 mm x 3"	12148	134.90
89 mm x 3"	12150	144.00
108 mm x 4"	12152	118.00
133 mm x 5"	12154	194.90
159 mm x 6"	12156	233.70
194 mm x 8"	12158	262.00



Galvanized Steel Female End Plug With Rubber Seal

Inch	mm	Code	Price
2	50	12070	65.70
3	76	12072	68.40
3.5	89	12074	77.70
4	108	12076	81.20
5	133	12078	91.80
6	159	12080	96.00
8	194	12082	138.40



Galvanized Steel Flanged Female Coupling With Rubber Seal – (Flange X Bauer)

Inch	mm	Code	Price
2	50 x 50	12180	163.20
3	80 x 89	12182	170.20
4	100 x 108	12184	197.70
5	125 x 133	12186	223.80
6	150 x 159	12188	263.40
8	200 x 194	12190	324.20



Galvanized Steel Flanged Male Coupling With Lever Ring – (Flange X Bauer)

Inch	mm	Code	Price
2	50 x 50	12194	216.80
3	80 x 89	12196	231.60
4	100 x 108	12198	254.90
5	125 x 133	12200	308.50
6	150 x 159	12202	378.50
8	200 x 194	12204	670.90



Galvanized Steel Male Coupling Threaded BSPM With Lever Ring – (Bauer X BSPM)

mm x Inch	Code	Price
50 mm x 2"	12162	77.70
76 mm x 3"	12166	163.20
89 mm x 3"	12168	177.90
108 mm x 4"	12170	209.00
133 mm x 5"	12172	285.90
159 mm x 6"	12174	331.90
194 mm x 8"	12176	555.80

we make life flow



Rodney
Industries

Vinidex
by aliaxis

aliaxis



TECHNICAL DRAWINGS

The following section includes drawings and dimensions for the following products:

- Galvanized Footvalves
- Polyethylene Footvalves
- Polyethylene Leaf and Lint Strainers
- Gate Check Valves
- Galvanized Tapers
- Galvanized 90° Bends

If you require technical drawings on additional products, please do not hesitate in contacting our office.

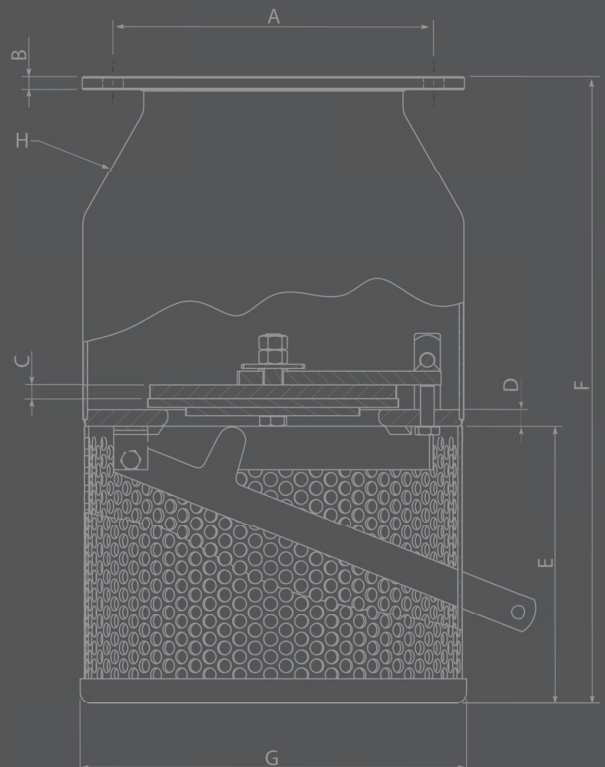

FOOTVALVE DIMENSIONS

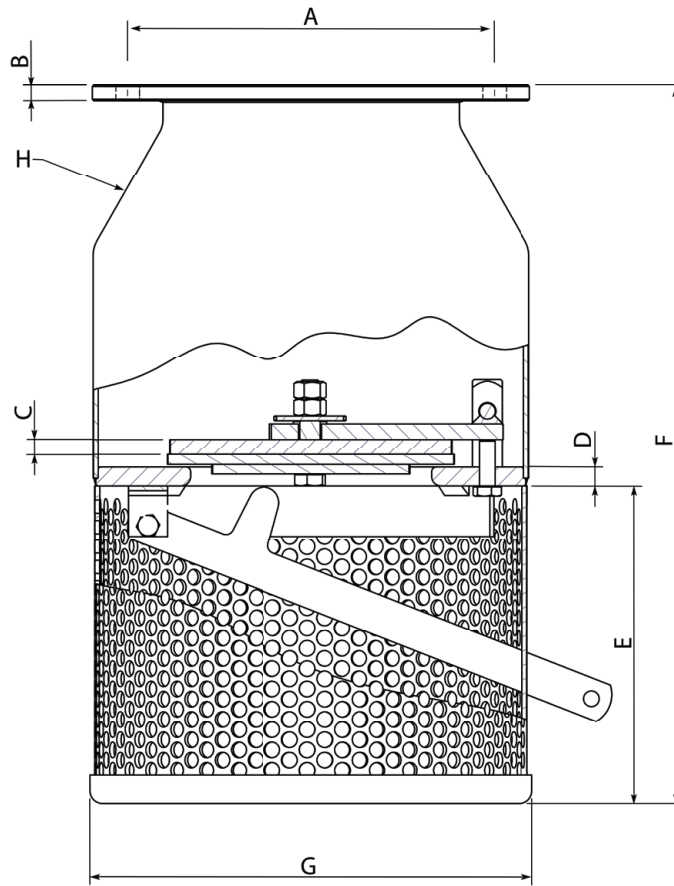

Size		A	B	C	D	E	F	G	H	Weight
mm	Inches	mm	mm	mm	mm	mm	mm	mm	mm	Approx kgs
80	3	146	10	10	12	178	372	188	3	10
100	4	178	10	10	12	178	393	220	3	11.7
125	5	210	10	10	12	203	448	258	3	16.2
150	6	235	10	10	12	203	459	283	3	18.5
175	7	260	10	10	12	230	500	310	2	20
200	8	292	12	12	16	278	595	340	3	30
250	10	356	12	12	16	312	676	405	3	42
300	12	406	12	12	16	364	776	455	3	53
350	14	470	16	16	20	408	897	525	3	82.5
375	15	495	16	16	20	432	920	550	2	86.5
400	16	521	16	16	20	470	975	585	2	98.4
450	18	584	20	20	25	505	1105	645	3	139
500	20	641	20	20	25	555	1180	710	3	178
600	24	756	20	20	25	665	1390	830	3	246
660	26	813	20	20	25	725	1510	875	3	280
750	30	927	25	20	32	820	1660	995	6	500

FOOTVALVE DIMENSIONS

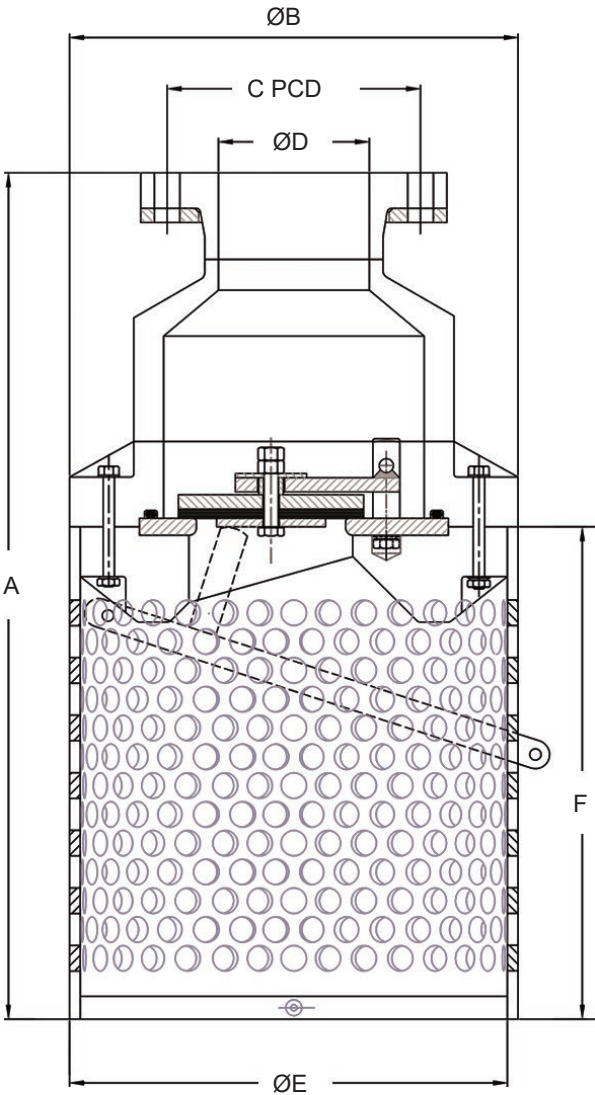

Footvalve	General Dimensions					
	A	ØB	C PCD	ØD	ØE	F
FVPS100	590	300	178 (4")	106	300	345
FVPS125	700	350	210 (5")	130	350	370
FVPS150	700	350	235 (6")	162	350	370
FVPS200	820	440	292 (8")	203	440	450
FVPS250	950	545	356 (10")	255	545	550
FVPS300	950	600	406 (12")	302	600	565

POLY LEAF AND LINT STRAINER DIMENSIONS

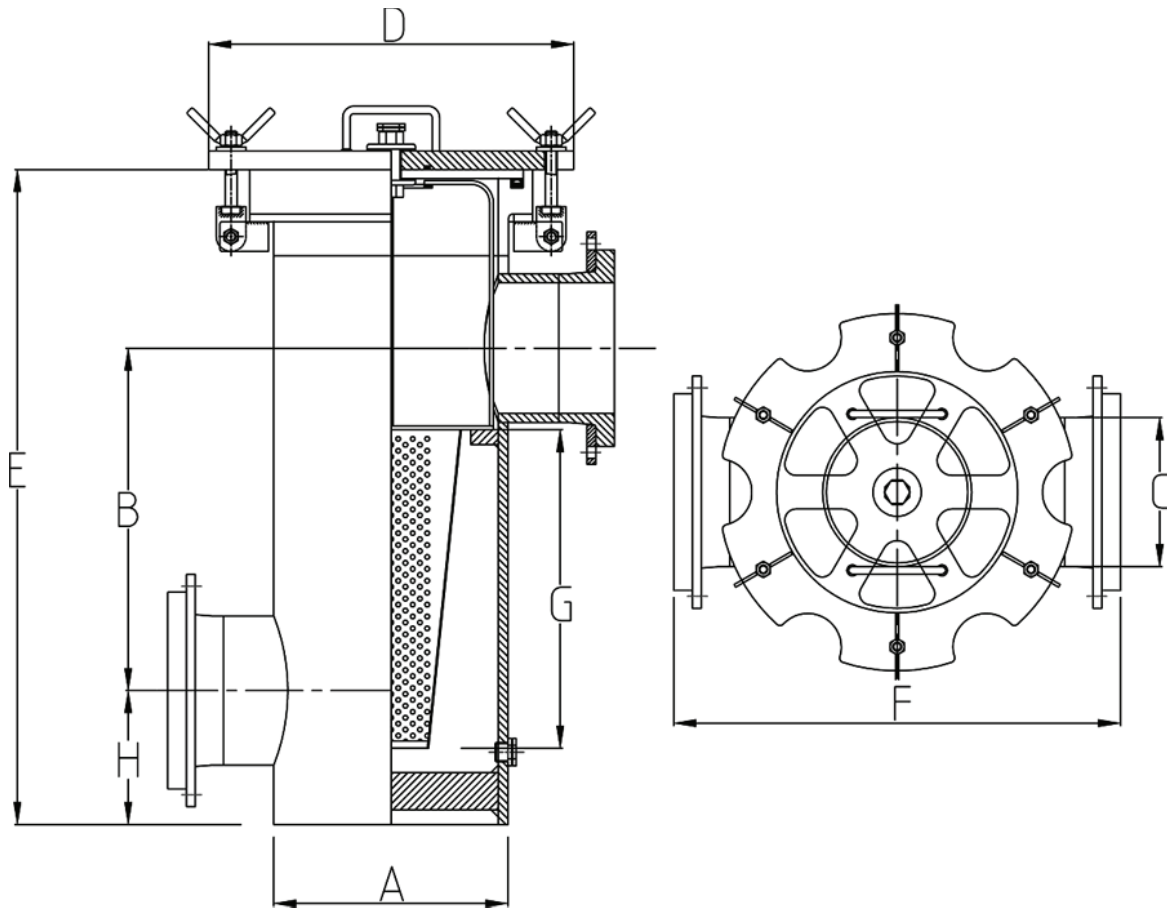

Strainer	Flow	Inlet	Outlet	A	B	C	D	E	F	G	H
LLS-010	10	90	90	315/17	500	90	480	940	570	475	180
LLS-015	10<15	110	90/110	315/17	500	110	480	940	570	475	180
LLS-030	15<30	160	110/160	315/17	500	160	480	940	570	475	180
LLS-050	30<50	200	160/200	400/17	500	200	570	990	700	475	225
LLS-075	50<75	225	200/225	450/21	500	225	635	1015	760	475	225
LLS-100	75<100	250	225/250	500/21	560	250	680	1140	800	490	250
LLS-710	TBA	355/630	355/630	710/17	766	355	900	1375	1300	n/a	760

PLEASE NOTE: OUR RANGE OF LEAF & LINT SUCTION STRAINERS ARE NOT PRESSURE RATED.

STANDARD DIMENSIONS

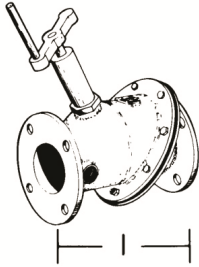

Combination Gate Check Valves

mm	inches	L (mm)
80	3	295
100	4	295
125	5	320
150	6	343
200	8	495
250	10	550
300	12	630

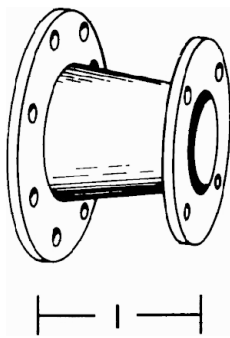

Galvanized Tapers

mm	inches	Light Wall	Med Wall	Heavy Duty
		L (mm)	L (mm)	L (mm)
40 – 80	1 ½ - 3	160	-	89
50 – 80	2 – 3	160	111	89
50 – 100	2 – 4	160	124	102
65 – 80	2 ½ - 3	160	111	89
80 – 100	3 – 4	160	124	102
80 – 125	3 – 5	160	149	127
80 – 150	3 – 6	160	162	140
100 – 125	4 – 5	160	149	127
100 – 150	4 – 6	160	162	140
125 – 150	5 – 6	160	160	140
125 – 200	5 – 8	220	174	152
150 – 200	6 – 8	220	174	152
200 – 250	8 – 10	220	-	178
200 - 300	44903	220	-	203

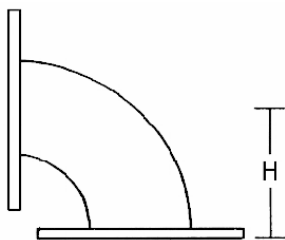

Galvanized 90° Bends

mm	inches	Light Wall	Med Wall	Heavy Duty
		H (mm)	H (mm)	H (mm)
80	3	124	124	114
100	4	210	162	152
125	5	250	200	190
150	6	290	240	230
200	8	302	317	305
250	10	385	-	385
300	12	457	-	457

Ri Rodney Industries
A Division of Vinidex Pty Ltd

19 Valente Close
Chermside QLD 4032
Phone: 07 3624 0300
Fax: 07 3624 0399
Email: sales@rodneyind.com.au
Web: www.rodneyind.com.au



an

aliasix
company