



# Lowara Smart Pump Range

PERMANENT MAGNET MOTORS WITH EMBEDDED DRIVE AND HIGH-EFFICIENCY HYDRAULICS

# Thinking efficiency? Start with smart systems.

It's time to think beyond single components. For top efficiency in residential and light industrial water supply and HVAC applications, you need the right combination of motors, variable speed drives and pumps – ensuring reliable performance, maximum savings and a rapid return on investment. You need the Lowara Smart Pump range.

## **Applications**

- Residential
- Light industrial
- HVAC
- Booster set
- OEM





# A complete system delivering market-leading efficiency

The Lowara Smart Pump range incorporates state-of-the-art technology to optimize performance, communicate with other building systems and help you achieve your goals. Choose preprogrammed packages for easy, cost-effective installation – and benefit from this system’s power, intelligence and performance.

## Power: best-in-class IE5 motor

Technical Specification IEC/TS 60034-30-2 introduces “ultra-premium” IE5 efficiency performance. It’s the top efficiency level for motors designed to not operate directly on-line. Each Lowara Smart Pump is equipped with a permanent magnet motor that meets this IE5 standards, providing efficiency well above a standard IE3 asynchronous motor.

## Intelligence: embedded MOTOR drive

The smart, easy-to-set integrated drive can operate single, twin or multipump systems of up to three pumps, with no need for an external control panel or PLC. The drive matches performance to demand, reducing energy use. And it allows smart pumps to communicate with other building systems in real time, maximizing efficiency.

## Performance: robust pump range

A full line of pumps providing enhanced hydraulic performance for residential, light industrial and OEM applications. The Smart Pump range can easily handle extreme environments, from -20°C to 50°C, without derating performance.

## Specifications

---

Voltage: single phase 230 V - three phase 400 V

---

Power: up to 2.2 kW

---

Multipump capability: up to 3 units

---

Power supply: 50/60 Hz

---

Comms: BACnet and Modbus standard in single pumps

---

IES2 package with IE5 motors

---

Enclosure rate: IP55

---

Ambient temperature: -20°C / +50°C full power

---

EMC: single phase C1 - three phase C2 category compliant EN 61800-3

---

Harmonics: compliant with IEC/EN 61000-3-2

---





Compare the Smart Pump footprint (NEW DESIGN) to the previous solution with TKS (OLD DESIGN). The Smart Pump offers higher performance with a reduced footprint.

## Extended working performances

smart hydraulic curve vs. previous solution with TKS

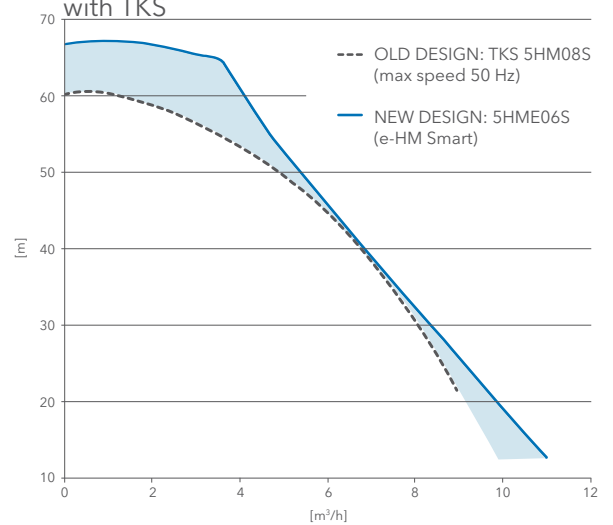

The embedded electronic drive called "e-SM" dramatically extends the working area of a pump to maximize flexibility and enhance system design. When coupled with multistage pump technology like e-HM, e-SV or VM, it presents a compact footprint, making it suitable for tight-space installations.

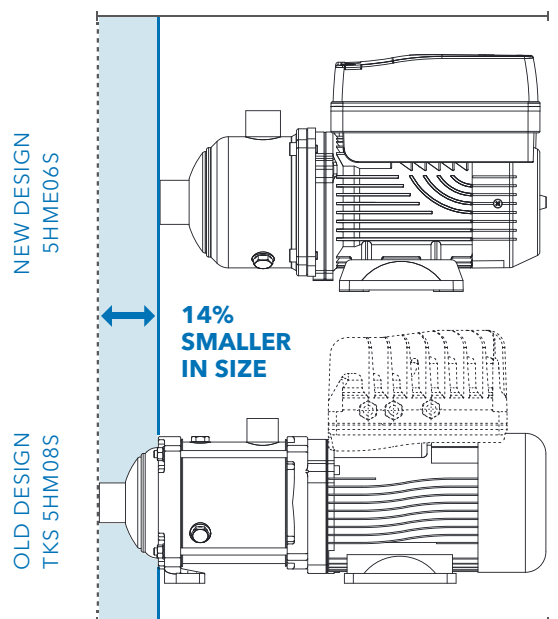

# Added Smart Pump benefits

## Discover the great trio of efficiency

Lowara Smart Pumps combine three essential elements to ensure outstanding reliability, optimal savings and the shortest payback times. It's not about individual components. It's about a great team of three perfectly concerted elements:

- Ultra-premium IE5 motors for best-in-class efficiency, according to IEC/TS 60034-30-2
- Power drive system (drive and motor) in the highest efficiency class, IES2, according to IEC 61800-9-2
- Hydraulic pump designed for exceptional Minimum Efficiency Index (MEI) ratings, according to EU Regulation No. 547/2012

## Enjoy plug-and-play ease

The all-inclusive Lowara Smart Pump range is easy to install and commission in new or retrofit applications. Standard BACnet and Modbus capabilities ensure quick connectivity and seamless integration with your building management system.

## Meet future EPA requirements today

Be ready now for future targets and requirements of new European water pump regulations. The Lowara Smart Pump range already exceeds new motor regulation requirements (EU) 2019/1781 and already meets the energy efficiency

requirements expected to be enforced on complete pump units (EPA - Extended Product Approach) and according to EN 17038 standard series.

What's more, the combined power drive system has achieved the highest IES class, IES2, according to IEC 61800-9-2. It's designed to work as a complete, integrated solution – so you can meet energy and operating efficiency goals today and tomorrow.

IES2

MEI EFFICIENCY HYDRAULICS



*Lowara offers the most efficient smart pump system to meet the EU's Extended Product Approach standards.*

## Controls, safety features and monitoring tools

Available control modes include:

- Control for constant pressure
- Control to match a system curve
- Control according to an external signal

In addition to these regulation functions, the Smart Pump range also:

- Stops the pump at zero demand
- Stops the pump in case of water failure
- Allows protection against dry running
- Has failure and over-temperature sensors for both the inverter and motor, which protects the pump and motor from under or over-voltage

The Smart Pump range offers a complete set of supervision and metering tools such as automatic test starts, auto smart cyclic change of lead and lag pump units, a memory for any inverter fault signals, and an operating-hours run counter. There's no need to configure the product; all the listed features are already included in the standard package.

## Why are filters needed?

If your smart pump is installed in a room with many electronic devices, and it has no THDi or EMC filters, computer monitors could start flickering uncontrollably. Filters eliminate such disturbances.

## Harmonics filters

Harmonics are produced by any device that uses a rectifier-based power supply, which draws current in non-sinusoidal curves: radio, TV, computer, washing machine, microwave oven, etc. Harmonics can reduce pump reliability, affect performance quality and increase operating costs. Each Smart Pump comes with a built-in total harmonic distortion current-active filter (THDi). This cuts interference to the minimum, less than 5%.

## Electromagnetic filters

The embedded electromagnetic compatibility filter (EMC) in each Smart Pump minimizes the transfer of electromagnetic noise between the drive and power supply mains. The range is fully compliant with the EN 61800-3, C1-category for single phase and C2-category for three phase product standards that apply to domestic premises, buildings and facilities directly connected to a low voltage (e.g. 230/400V) main supply.

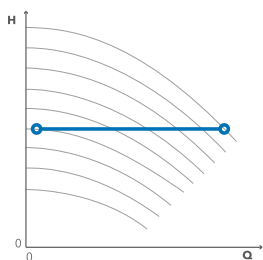

Control for constant pressure

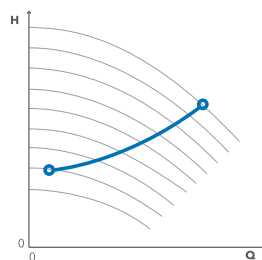

Control to match a system curve in multistage Smart ranges like e-HME, e-SVE, VME

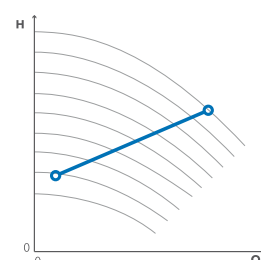

Control to match a system curve in in-line Smart ranges like e-LNEEE, e-LNESE

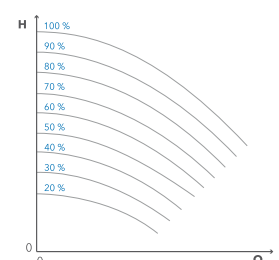

Control according to an external signal

# Smart Pumps for pressure boosting

## Smart Pump range

Smart Pumps are not only smart. They're smooth. They operate steadily in partial loads, which prevents the water hammer that's normally associated with full speed pumps. What's more, their accurate speed control during operation and their smooth start-up reduce mechanical stress and wear.

Available from 0.37 to 2.2 kW, Smart Pumps are easy to commission, set up and operate using the simple start-up menu. Parameters and alarms appear on an easy-to-read display designed to provide complete control of system operation. They're easy to program too, with just three keypad touches.

Each Smart Pump features an IE5 motor for best-in-class efficiency and enhanced hydraulic performance. The range has an IP55 enclosure rate, and includes BACnet and Modbus capability for seamless building management system integration in all stand-alone configurations. The drive is suitable for installations from -20°C to 50°C without power derating.

## Applications

- Water supply systems in residential buildings
- Air conditioning
- Water treatment plants
- Industrial installations







## e-HME: Ensuring a reliable water supply

This robust line of Smart Pumps combines state-of-the-art hydraulics with best-in-class efficiency for the lowest possible operating costs. Five ranges offer flexibility for a wide range of applications. They include residential and commercial pressure boosting, industrial and HVAC, and irrigation.

- IES2 drive with permanent magnet motor for top efficiency
- More compact than the fixed-speed version, meeting the same duty points with precision and consistency
- Thick stainless steel casing, high-quality bearings, and stainless steel inner components minimize noise and guarantee long service life
- Certified for drinking water use (WRAS and ACS)
- Options include AISI 304 or 316 pump body and inner components, electropolished and passivated, and mechanical seal or O-rings

### Specifications

Delivery: up to 30m<sup>3</sup>/h

Head: up to 158m

Liquid temperature: up to 120°C

Pressure: PN16

Power range: 0.37-2.2 kW

### Performance Curve

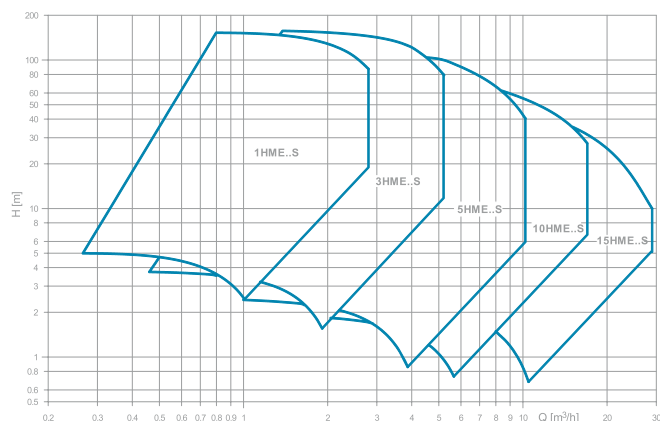

# Smart Pumps for pressure boosting



## VME: Ultra-compact vertical multistage pumps

An ultra-compact and cost-effective version of the e-SVE, it's designed for a wide range of applications, particularly where space is at a premium. Multiple construction designs are available, as are special versions.

- Compact design is made possible by Noryl® impellers, which allow higher head compared to stainless steel impellers
- Vertical configuration and threaded ports save space in narrow installations
- Even more compact than the fixed-speed version for the same duty points, thanks to the speed control drive and permanent magnet motor
- High-efficiency IES2 drive and motor produce significant energy cost savings
- Meets the duty point in a stable and precise way when duty points change, whether quickly or over time due to long-term plant performance degradation
- Easy to commission and integrate thanks to the connected pressure sensor and its intuitive user interface
- Certified for drinking water use (WRAS and ACS)

## Performance Curve

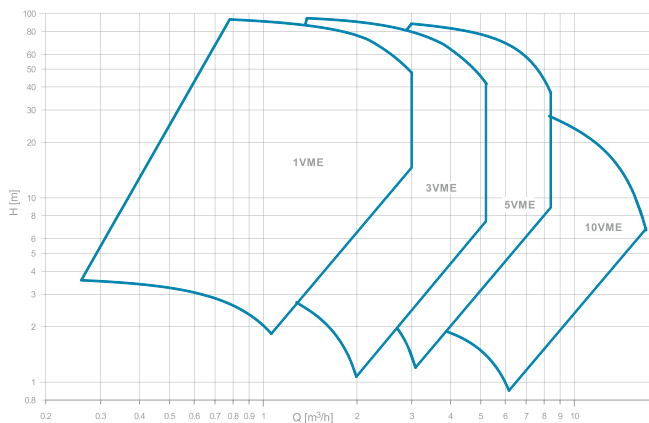

## Specifications

Delivery: up to 17m<sup>3</sup>/h

Head: up to 100m

Liquid temperature: up to 90°C

Pressure: PN10

Power range: 0.37-2.2 kW

# e-SVE: Stainless steel vertical multistage pumps

Smart high-efficiency hydraulics yield the lowest possible operating costs for a variety of applications, including residential and light commercial, OEM applications and HVAC. Six ranges offer multiple construction designs, with special versions available.

- IES2 drive with permanent magnet motor for top efficiency
- More compact than the fixed-speed version, meeting the same duty points with precision and consistency
- A variety of connections (threaded, round, clam and oval flanges, Victaulic) configured vertically; ports can be on the same side to save space
- Designed for fast, easy maintenance with a balanced mechanical seal, an O-ring seat design and a replaceable diffuser wear ring
- Reduced impeller axial thrust for longer standard motor bearing life
- Certified for drinking water use (WRAS and ACS)
- Options include high-temperature seals, low NPSH design, high pressure design, and passivated and electropolished versions



## Specifications

Delivery: up to 30m<sup>3</sup>/h

Head: up to 235m

Liquid temperature: up to 120°C

Pressure: PN25

Power range: 0.37-2.2 kW

## Performance Curve

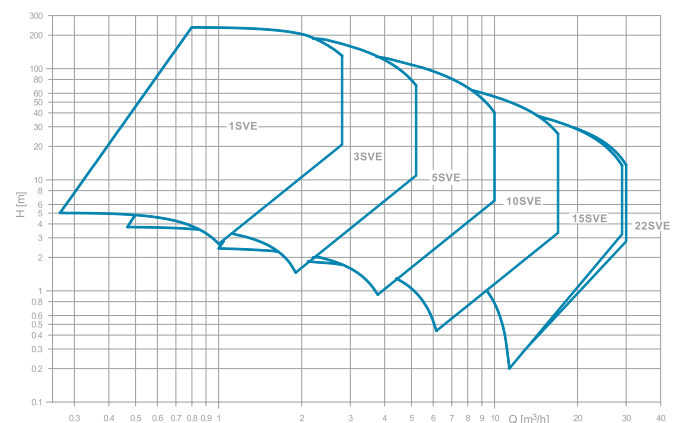

# Variable speed booster sets

## SMB: Smart booster sets

The SMB series is designed for water boosting and transfer. It uses the latest technology to easily deliver water at the correct pressure and flow for residential and light commercial applications.

- Variable speed operation ensures smooth pressure control and quiet performance without water hammer
- IES2 and highest hydraulics efficiency save money and reduce lifecycle costs
- Pressure remains constant, despite frequent variations in water consumption
- Smart curves create compact design
- R version available with suction and delivery manifolds on same booster side for an even smaller footprint
- Certified for drinking water use (WRAS and ACS)
- Communication via Modbus and BACnet with optional cards

The smb series is available with two and three pumps

- e-HME series: horizontal multistage pumps
- e-SVE series: vertical multistage, stainless steel pumps
- VME series: vertical multistage, monolithic pumps

## Specifications

---

Delivery: up to 90m<sup>3</sup>/h

---

Head: up to 156m

---

Liquid temperature: up to 80°C

---

Power range: up to 2.2 kW per pump

---



**SMB**  
Shown with two  
VME pumps



**SMB**  
Shown with three  
e-SVE pumps



## Added benefits

### Plug and pump Booster set

The system is easy to commission and operate, thanks to friendly HMI with a preset package. The unit features stainless steel manifolds, vibration dampers, a non-return valve and two gate valves per pump. The single phase solution is rated C1 class level, while the three phase solution is rated C2 class level, so there's no need for further EMC filters. It's also suitable for harsh environments with an IP55 enclosure rate. Analog input 0-10V is available for external control. The system is designed to work in extreme conditions up to 40°C without derating.

### Reliability

Get multipump control without an external control panel. SMB booster sets are equipped with one pressure transducer per pump through 4-20 mA signal. Operation is still possible, even when one or more pumps or sensors are unavailable.

### Individual pump control

Each individual pump has the capability to take control. That means that the system will continue to operate as a booster system even if one or more of the pumps or sensors is unavailable. Compared to systems with only one control unit, the SMB series is an extremely reliable source of pressure.

### One sensor – one pump

The SMB series includes one sensor per Smart Pump as standard, providing full redundancy and avoiding a unique failure point.

### Safe operation

Each frequency drive comes with contacts for fault diagnostics and dry-run protection connections as standard. Each e-SM drive frequency converter features an automatic switch for thermal magnetic protection. The system incorporates cyclical exchange of pumps, temperature sensors in motors and drives, and error logs.



# Smart Pumps for HVAC

## e-LNEEE/e-LNESE and e-LNTEE/e-LNTSE: Single and twin in-line pumps

### Specifications

Delivery: up to 44m<sup>3</sup>/h

Head: up to 41m

Available sizes: DN32, DN40, DN50

Power: up to 2.2 kW

Liquid temperature: -25°C to +120°C  
(+140°C on demand)

No transducers needed, sensorless version



### Performance Curve e-LNEEE/e-LNESE

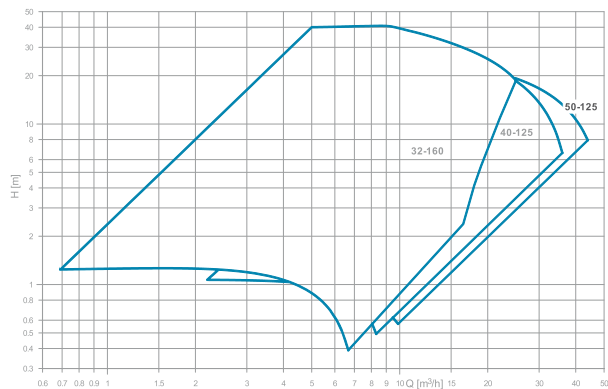

### Performance Curve e-LNTEE/e-LNTSE

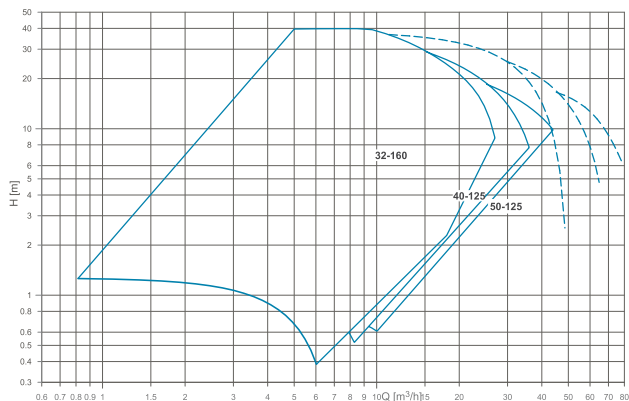

The dotted lines are the performances of the units operating in parallel.

## Reduce HVAC system costs



Choose e-LNE Smart Pumps to meet efficiency goals – and save money over the life of the system.



### Cost-effective installation and integration

Modbus and BACnet are standard on single pumps and optional for twin heads. Choose a sensorless system for an easier, faster and less expensive installation.



### Increased efficiency

High-efficiency hydraulics combined with an IE5 permanent magnet motor and an IES2 power drive means the lowest possible operating costs – adding up to significant savings over the system lifecycle.

### A better curve

Variable speed drives enable the system to work along the curve based on demand. This enhances hydraulic performance an average 20% over fixed-speed installations.

### Versatility

A wide range of options ensures that there's a pump for your application, making this system the ideal solution for heating and cooling applications, commercial building systems, water transport and light industrial processes. In addition, the twin configuration will provide redundancy to the system, and the two heads can work in parallel.

### Easy maintenance

A pullback design makes it easy to extract the impeller and motor without disconnecting the pump body from the piping system. Intuitive drive interfaces with digital displays further simplify setup and control.

### Extended life

Matching performance to demand helps prevent water hammer and other mechanical stresses, extending equipment life. The intelligent components also maintain pump performance in extreme conditions. Dry run protection, temperature and voltage sensors, and error logs keep the system safe and under control.

# Xylem |'zīləm|

- 1) The tissue in plants that brings water upward from the roots;
- 2) a leading global water technology company.

We're a global team unified in a common purpose: creating advanced technology solutions to the world's water challenges. Developing new technologies that will improve the way water is used, conserved, and re-used in the future is central to our work. Our products and services move, treat, analyze, monitor and return water to the environment, in public utility, industrial, residential and commercial building services, and agricultural settings. With its October 2016 acquisition of Sensus, Xylem added smart metering, network technologies and advanced data analytics for water, gas and electric utilities to its portfolio of solutions. In more than 150 countries, we have strong, long-standing relationships with customers who know us for our powerful combination of leading product brands and applications expertise with a strong focus on developing comprehensive, sustainable solutions.

**For more information on how Xylem can help you, go to [www.xylem.com](http://www.xylem.com)**



For information and technical support  
Xylem Service Italia Srl

Via Dottor Vittorio Lombardi 14  
36075 - Montecchio Maggiore (VI) - Italy  
Tel. (+39) 0444 707111  
Fax (+39) 0444 491043  
[www.lowara.com](http://www.lowara.com)  
[www.xylem.com](http://www.xylem.com)

Xylem reserves the right to make modification without prior notice.  
Lowara, Flygt and Xylem are trademarks of Xylem Inc. or one of its subsidiaries. © 2018 Xylem, Inc.